

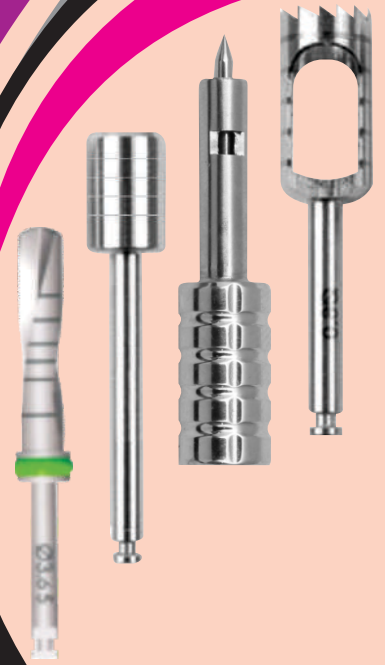

Catalogue 2020-21

19 Years of Serving
19 Años de su Servicio



NEODENTAL
INSTRUMENTOS DENTALES

639 942774

neodentallevante@gmail.com

Stock Available/
Stock Disponible

24
hrs / hora



**Extracting Forceps (English pattern)/
 Forceps de Extraccion (Forma ingles)**

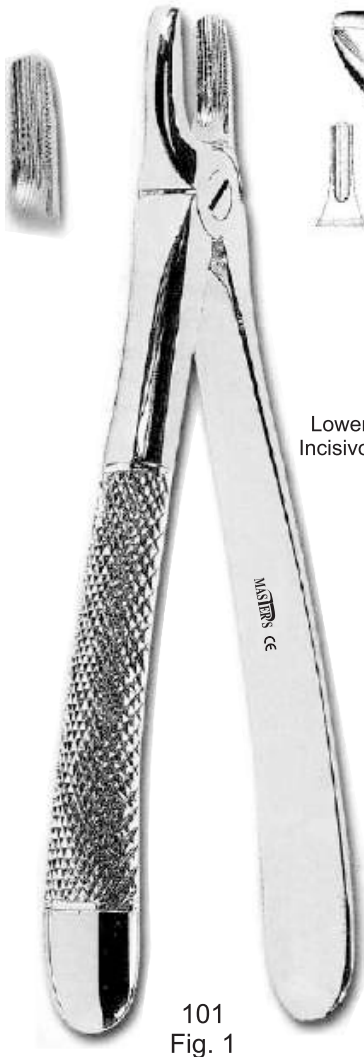

101
Fig. 1

Upper Centrals & Canines
Incisivos y caninos superiores

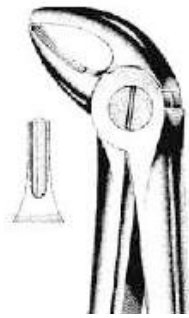

104
Fig. 4

Lower Centrals & Canines
Incisivos y caninos inferiores

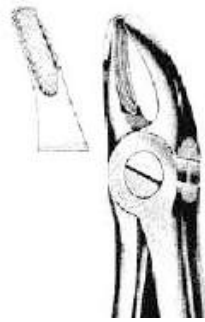

105
Fig. 7

Upper Premolars
Premolares Superiores



106
Fig. 8

Lower Premolar
Premolares Inferiores

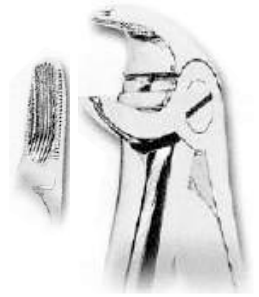

107
Fig. 13

Lower Premolar
Premolares Inferiores

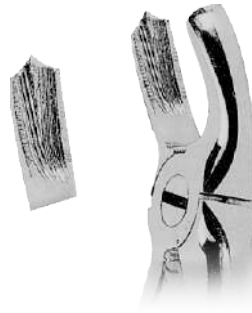

108
Fig. 17

Right Upper Molars
Molares Superiores Derechos

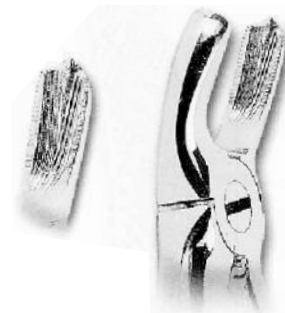

109
Fig. 18

Left Upper Molars
Molares Superiores Izquierdos



113
Fig. 21

Lower Molars
Molares Inferiores



114
Fig. 22

Lower Molars
Molares Inferiores



122
Fig. 33

Lower Roots
Raices Inferiores



123
Fig. 33A

Lower Roots
Raices Inferiores



130
Fig. 51A

Upper Roots Narrow Beak
Raices Superiores



**Extracting Forceps (English pattern)/
Forceps de Extraccion (Forma ingles)**

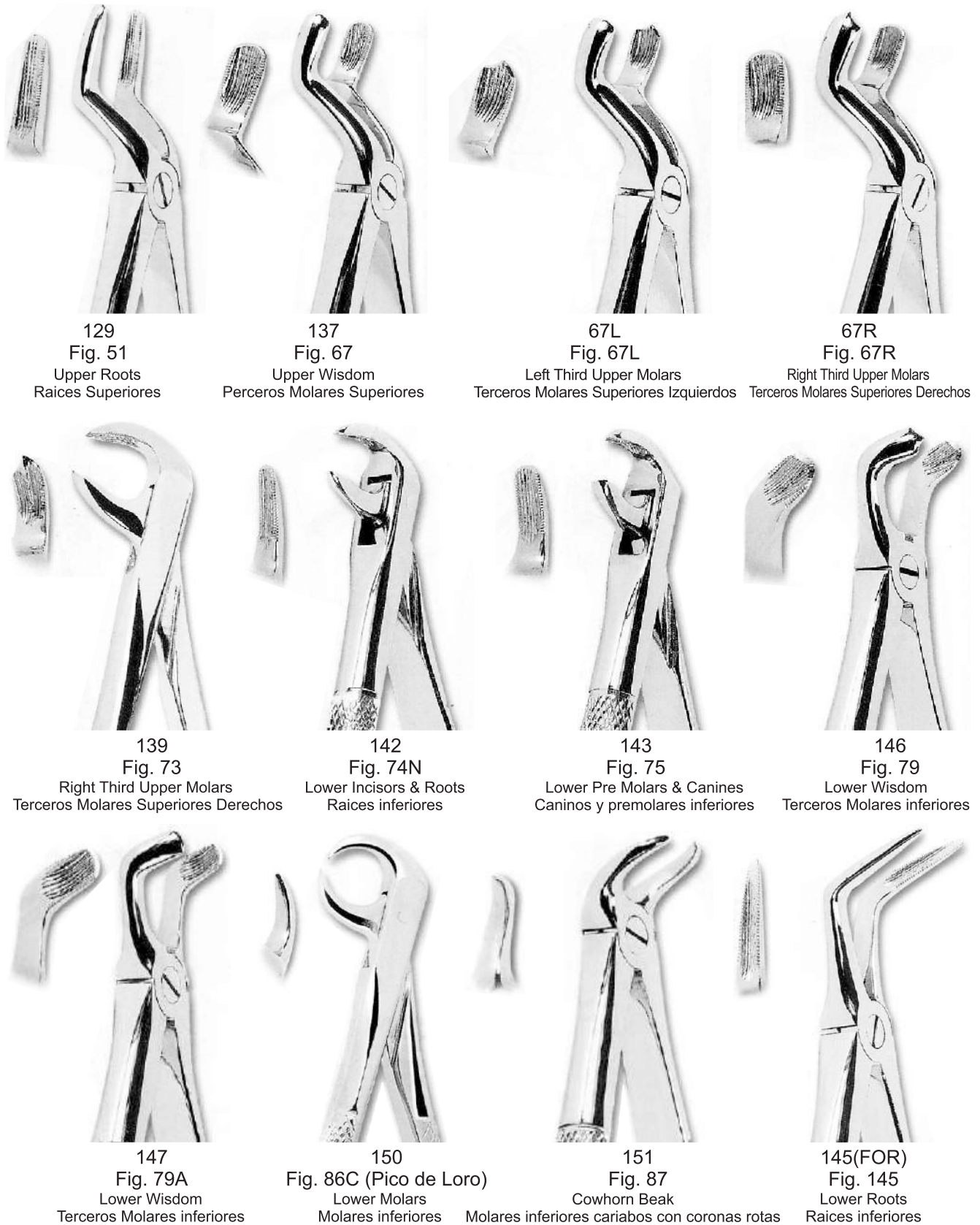



**Extracting Forceps (English pattern) /
 Forceps de Extraccion (Forma ingles)**

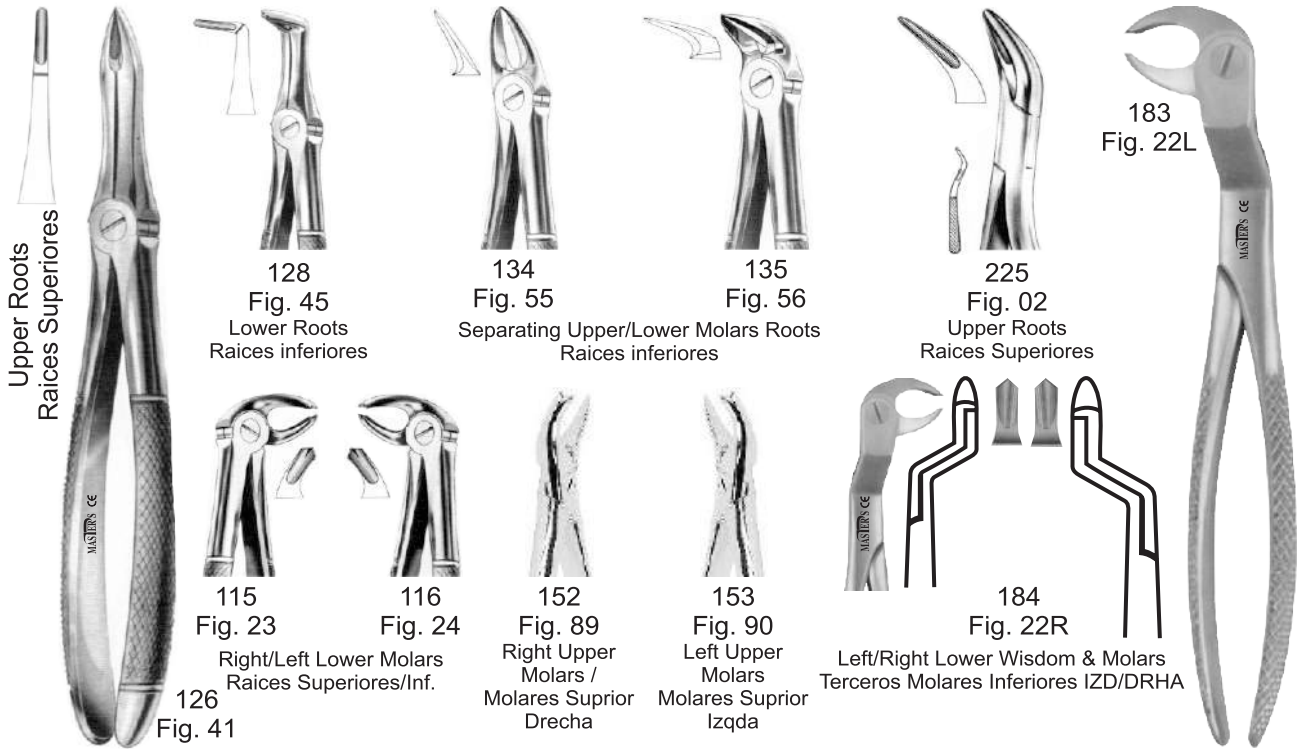

**Extracting Forceps (American Pattern) /
 Forceps de Extraccion (Forma Americana)**

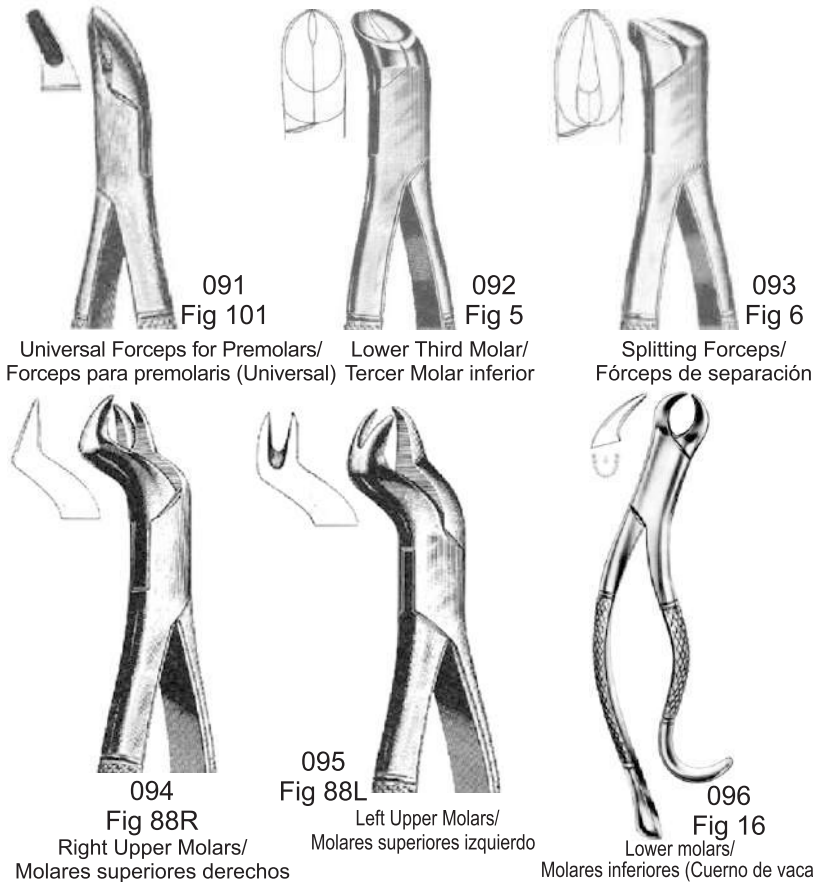

1546
 Kit of forceps 11pcs (Adult) /
 Juego de forceps 11unidad (Adulto)
 Fig. 01, 07, 13, 17, 18, 22, 33, 51A, 67A, 79, 86C
 (English Pattern / Forma ingles)



**Extracting Forceps (Children - English pattern) /
 Forceps de Extraccion (Niños - Forma ingles)**

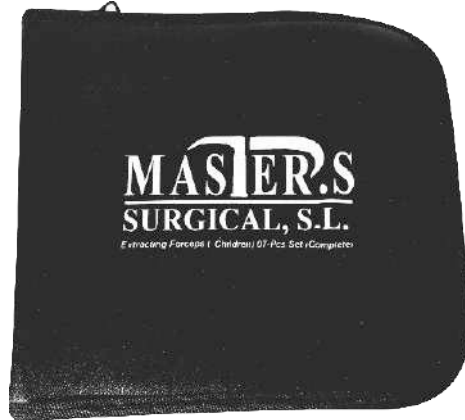
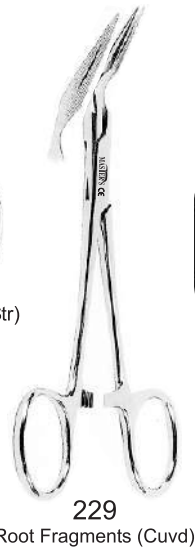
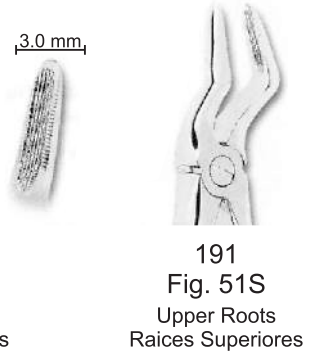
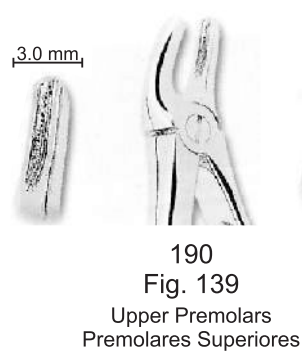
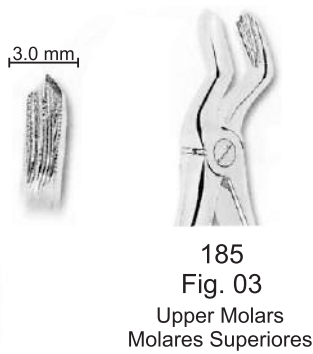
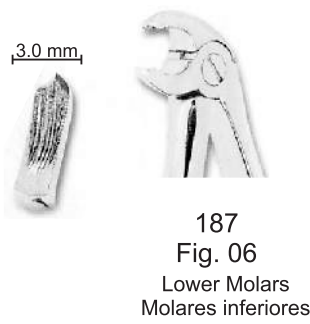
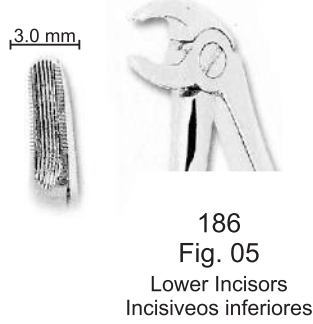

1545
 Kit of Forceps 7 pcs Children (Complete) /
 Kit de fórceps 7 piezas Niños (Completo)





Bone Rongeurs
Pinza Gubias

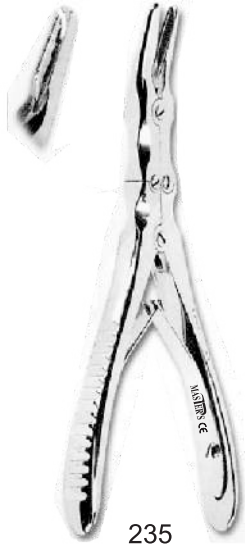

235
Ruskin-Mini
15.5 cm



230
Blumenthal 30°
15 cm



231
Blumenthal 45°
14.5 cm



232
Blumenthal 90°
14 cm

Suction Tubes / Canulas de aspiracion quirurgica

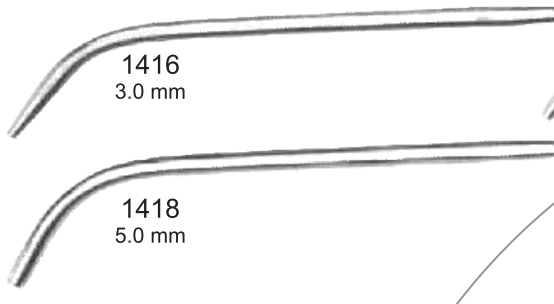

1416
3.0 mm

1417
4.0 mm

1418
5.0 mm



1851
Pean / Kochar Curved
16cm



011
Auto Matrices
Kit Complete /
Kit Completo
14.6cm (Inox)



012
Handle Auto Matrices
Only Handle / Solo Mango
11cm (Inox)
(Reposicion)



013
Point Auto Matrices
Only point / Solo punta
4.5cm (Inox)
(Reposicion)



437-R
Mosquito (Str)
12 cm



437-C
Mosquito (Cuvd)
12 cm



Retractors
Retradores

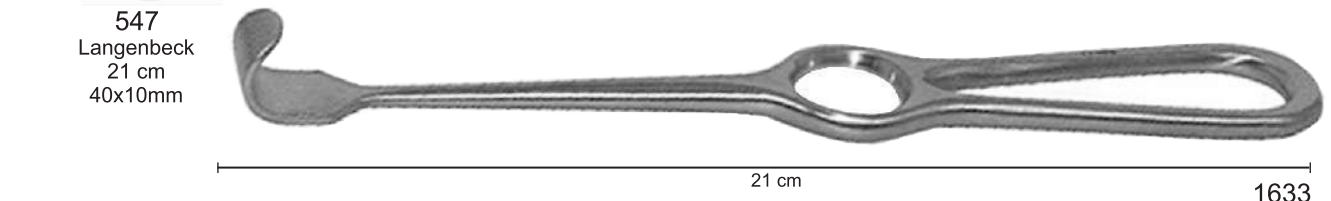

KIT DE OBTENCION DE INJERTO DE TIBIA O CADERA

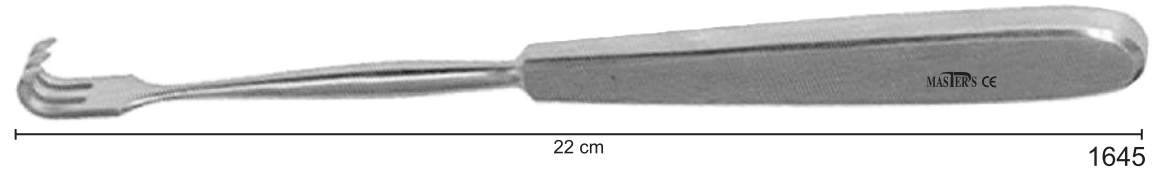

RETRACTORES DE APICECTOMIA, DENTADAS



RETRACTORES DE APICECTOMIA, DENTADAS



Root Elevators
Botadors

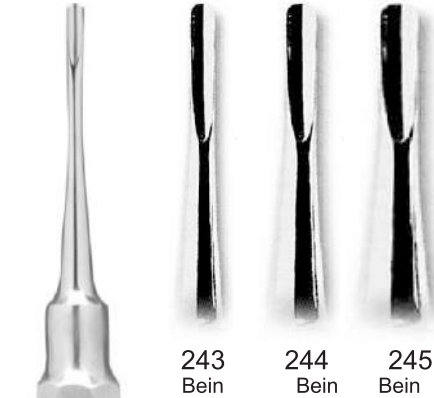
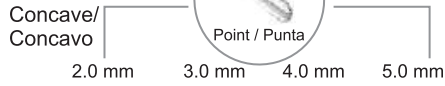

243 Bein
 244 Bein
 245 Bein

242 Bein



321 Bein
 322 Bein

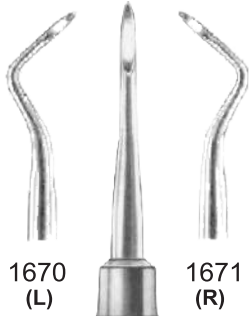

1670 (L)
 1671 (R)



325 Heidbrink

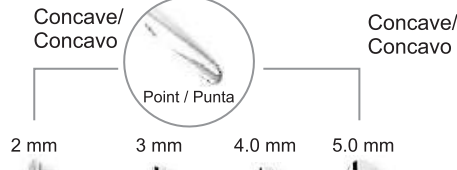

314 Bein
 315 Bein
 320 Bein

313 Bein

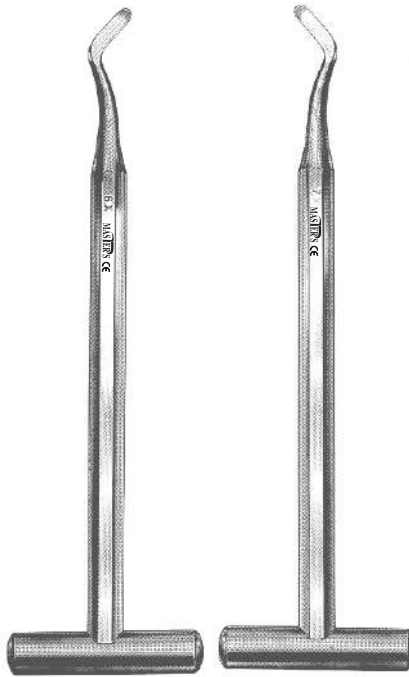

1800 (Left) Pott
 1800 (Right) Pott

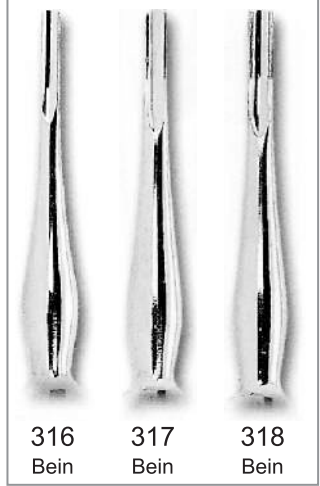
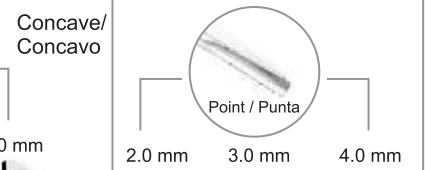

316 Bein
 317 Bein
 318 Bein

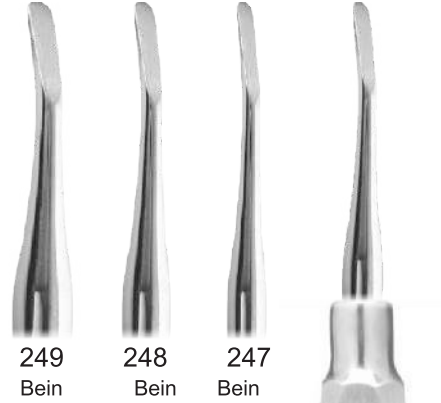
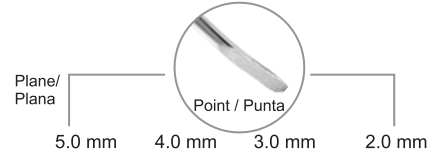

249 Bein
 248 Bein
 247 Bein



246 Bein

Root Elevators
Botado



264
 Seldin
 Fig 23



265
 Seldin
 Fig 24



282
 Fig. 44
 Cryer



283
 Fig. 45
 Cryer



Walter F. Barry



327
 Fig. 320



328
 Fig. 321



1500
 Fig. 370



1501
 Fig. 371



579



295-5



578



1051
 Napkin Holder
 with Plastic Band

1052
 Napkin Holder
 with Metal Chain



577
 Chompret
 15 cm

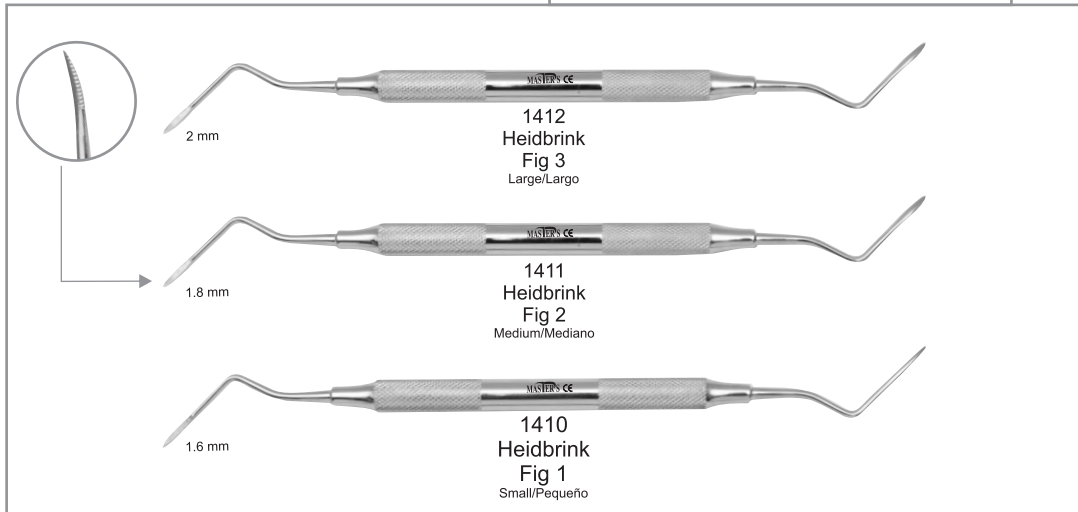

2 mm

1412
 Heidbrink
 Fig 3
 Large/Largo

1.8 mm

1411
 Heidbrink
 Fig 2
 Medium/Mediano

1.6 mm

1410
 Heidbrink
 Fig 1
 Small/Pequeño

Luxator/luxador

New

1568	1mm STR		Recta
1569	2mm STR		Recta
1570	3mm STR		Recta
1571	3mm Curved		Curva
1567	4mm STR		Recta
1572	5mm STR		Recta
1573	5mm Curved		Curva

MASTERS CE

Plane Point
Punta Plana

Luxator/luxador

1699	1mm S		Recta
1700	2mm S		Recta
1701	3mm C		Curva
1702	3mm S		Recta
1703	3mm CA		Curva Angulo
1704	3mm IC		Up Curved
1698	4mm S		Recta
1705	5mm C		Curva
1706	5mm S		Recta
1707	3mm DE		Recta
1708	5mm DE		Recta

MASTERS CE

Luxator Metal Handle /Luxador Con Mango de Metal

New

1568MT	1mm STR		Recta
1569MT	2mm STR		Recta
1570MT	3mm STR		Recta
1571MT	3mm Curved		Curva
1567MT	4mm STR		Recta
1572MT	5mm STR		Recta
1573MT	5mm Curved		Curva

MASTERS CE

Plane Point
Punta Plana

1699MT	1mm S		Recta
1700MT	2mm S		Recta
1701MT	3mm C		Curva
1702MT	3mm S		Recta
1703MT	3mm CA		Curva Angulo
1704MT	3mm IC		Up Curved
1698MT	4mm S		Recta
1705MT	5mm C		Curva
1706MT	5mm S		Recta
1707MT	3mm DE		Recta
1708MT	5mm DE		Recta

MASTERS CE

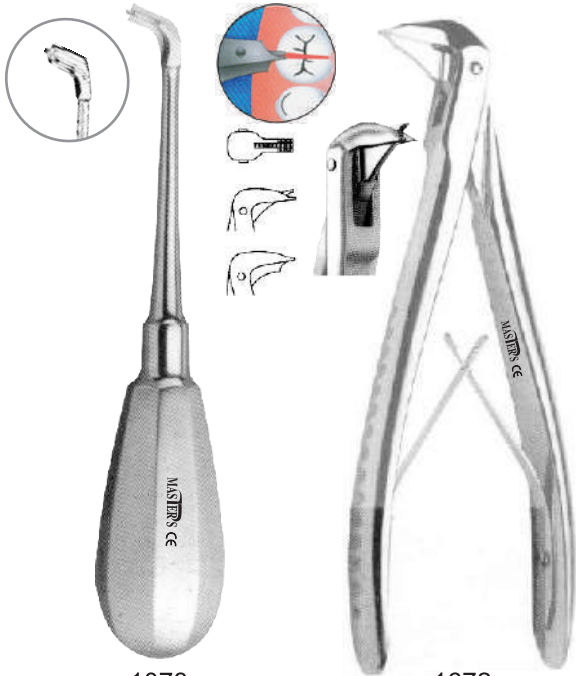

1073
 Crown Spreader
 (Universal)

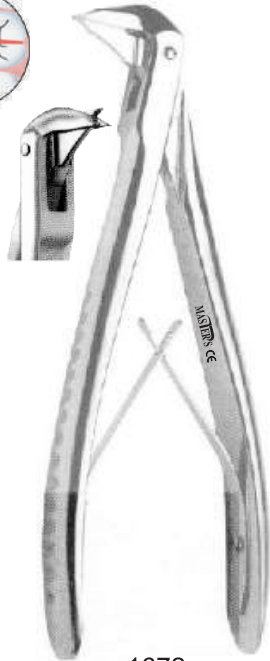

1672
 Crown Remover
 Beerendonk
 mm 130



1078
 Crown Remover



A B C
 3 Point Complete Set



A B C
 Only 3 point set/
 Solo juego de puntas
 090

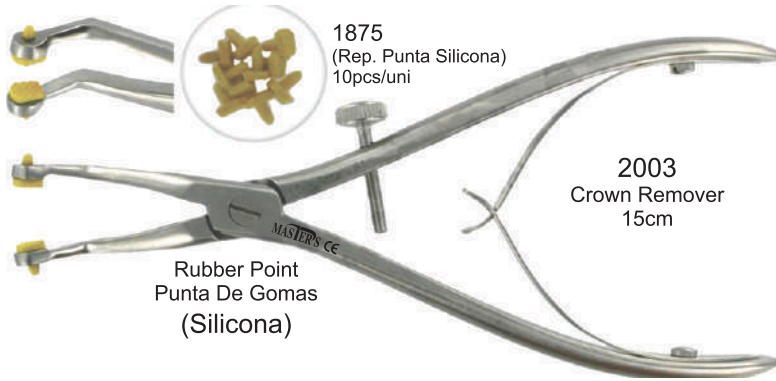

1875
 (Rep. Punta Silicona)
 10pcs/uni
 2003
 Crown Remover
 15cm
 Rubber Point
 Punta De Gomas
 (Silicona)

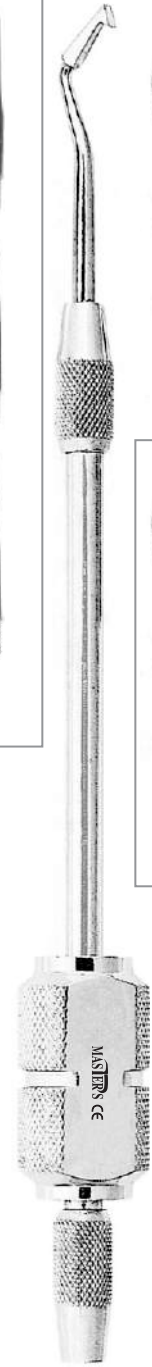

1076
 Crown Remover



2004
 Crown Remover
 15cm



2005 L
 Crown Remover
 LEFT/IZQ



2005 R
 Crown Remover
 RIGHT/DRHA



SEPARADOR LABIAL

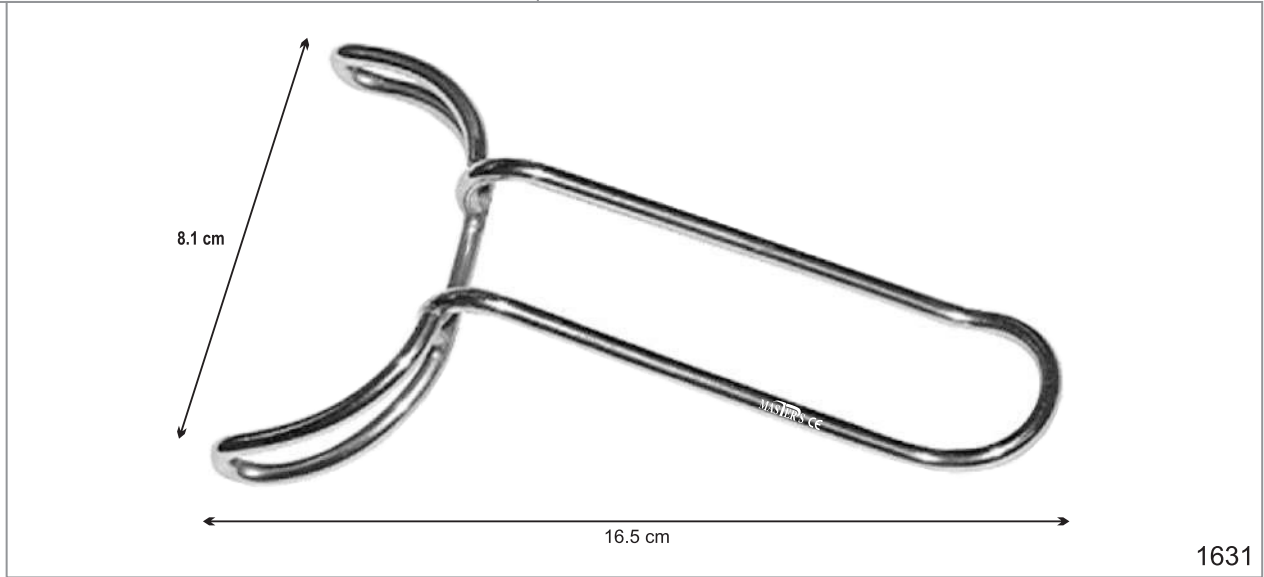

1631

RETRACTOR PARA LABIAL



1583-A

Mouth Gauge
Abre Bocas



1870-2
Molt
14 cm

1870-1
Molt
11 cm

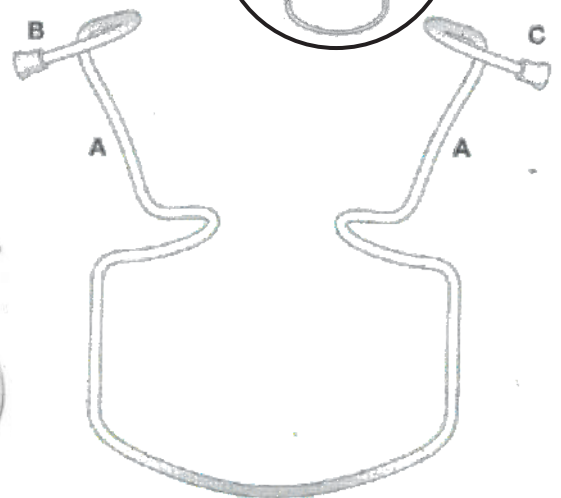
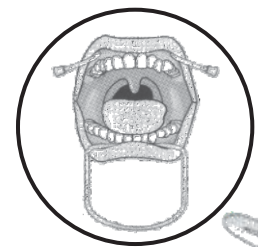

Oringer

- 1403 Small - Pequeño 40 x 105 mm
- 1404 Medium - Mediano 50 x 110 mm
- 1405 Large - Largo 60 x 115 mm



Needle Holder
Porta Aguja

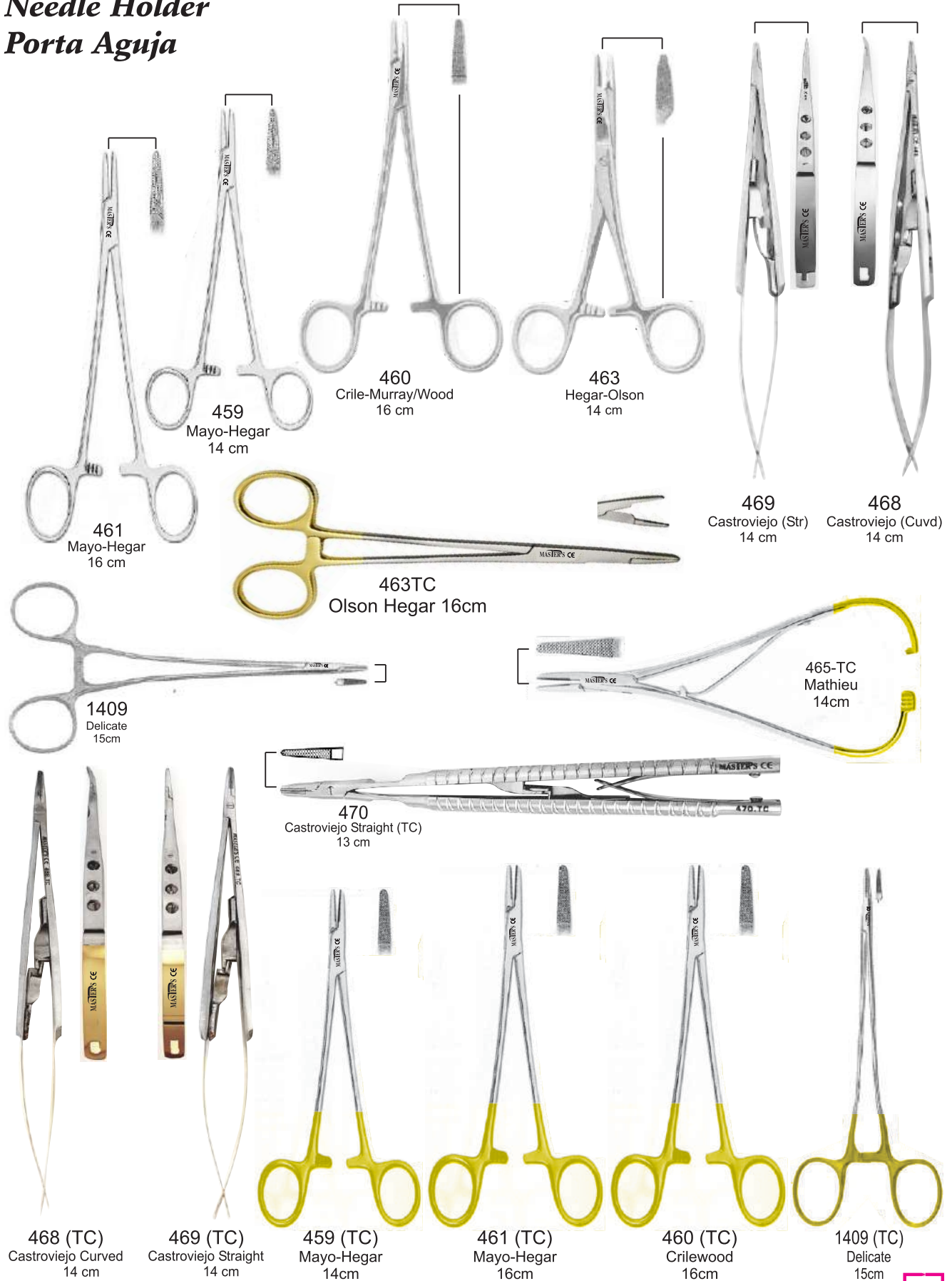

Dental Syringes
Jeringas Dentales



1037
1.8 ml
Ineralgimetary Syringe

Needle Screw European.
Aguja Rosca Europeo.



1686
Ineralgimetary Syringe Str (inox)

MI 1.8
mm 110



1408
Ineralgimetary Syringe Cvd (inox)

MI 1.8
mm 110

New
New system with Button
Nuevo sistema con Boton



1407
Ineralgimetary Syringe Str (inox)

MI 1.8
mm 110

New
New system with Button
Nuevo sistema con Boton

Special Aspirating Point/
Punta de aspiración especial



New



2118
Dental Cartridge
Syringe (Classic)



1040
Aspirated Syringe



1039
Aspirated Syringe



1041
Cartridge Syringe (Folding)
(ARTICULADA)

Folding/
Articulada



1414
Aspirated Syringe
1.8 mm
(ARTICULADA)

New



New Model with
3 aspirating hooks,
utilizable only
on hollow small
rubber caps.

Nuevo modelo
con 3 ganchos
utilizo solo
con goma hueca.



1415
Aspirated Syringe (Auto)
1.8 mm

New



Scissors
Tijeras

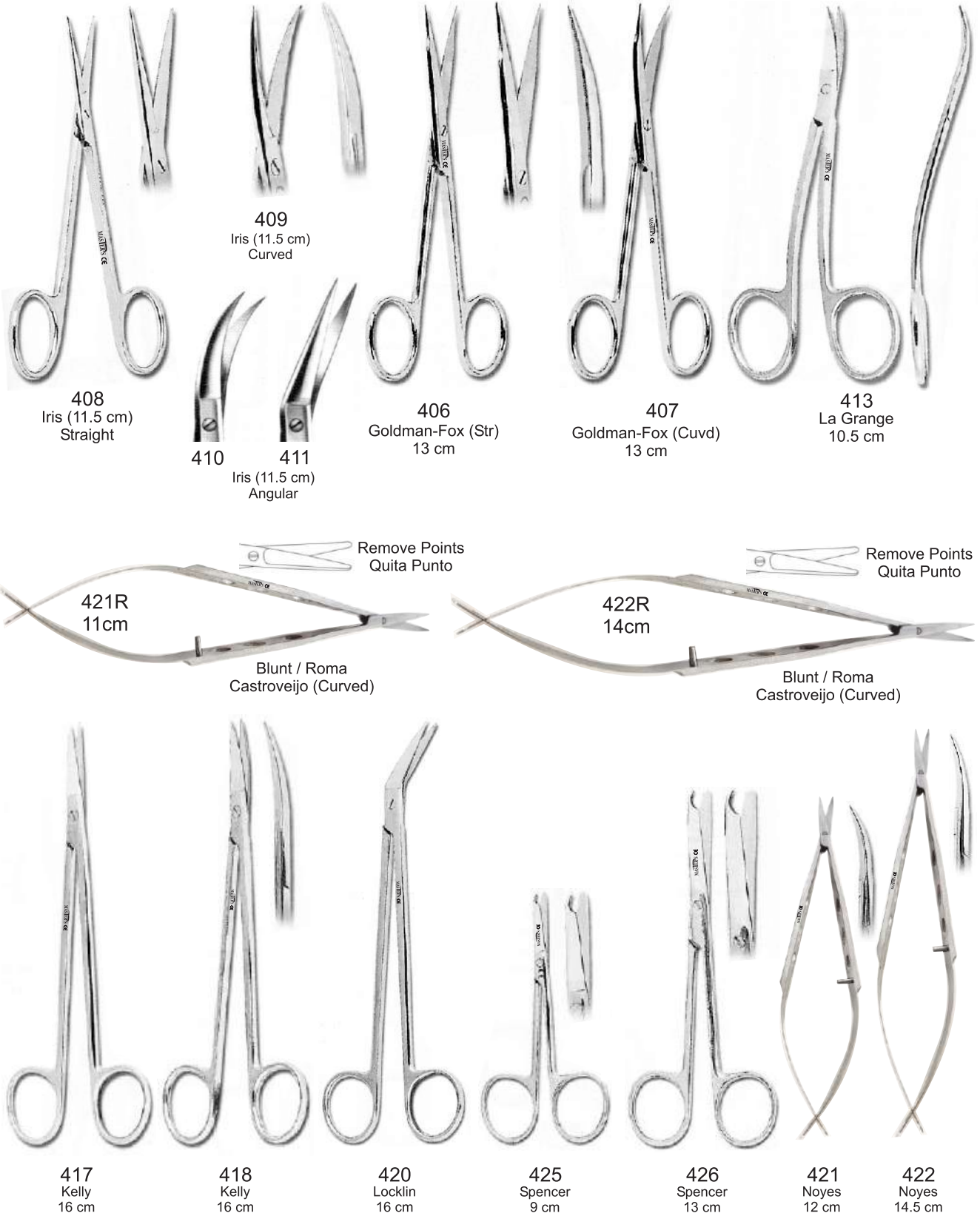



Tweezers "Cotton & Tissue"
Pinza Para Algodon Y Cirugia

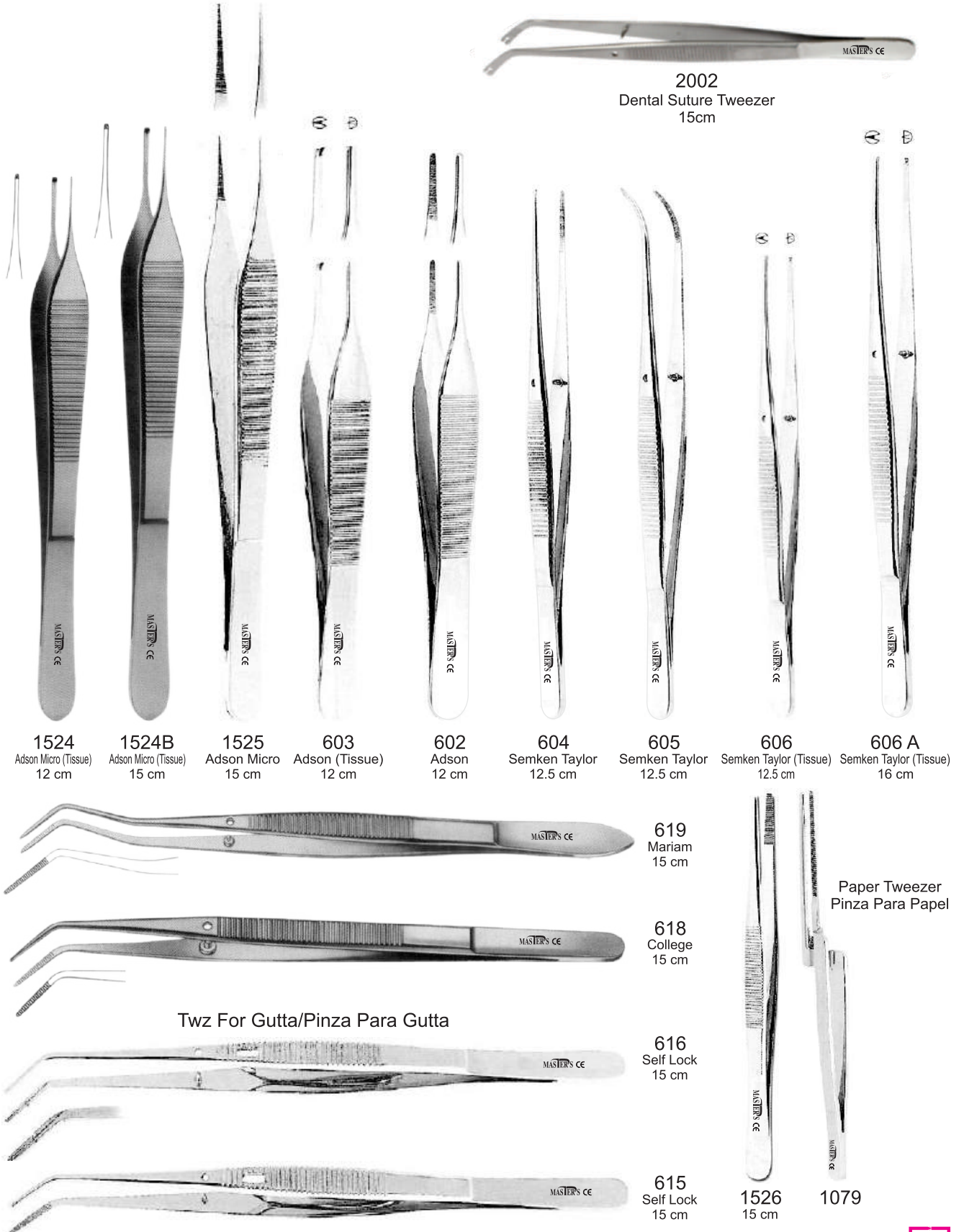

1524
Adson Micro (Tissue)
12 cm

1524B
Adson Micro (Tissue)
15 cm

1525
Adson Micro
15 cm

603
Adson (Tissue)
12 cm

602
Adson
12 cm

604
Semken Taylor
12.5 cm

605
Semken Taylor
12.5 cm

606
Semken Taylor (Tissue)
12.5 cm

606 A
Semken Taylor (Tissue)
16 cm

2002
Dental Suture Tweezer
15cm

619
Mariam
15 cm

618
College
15 cm

Twz For Gutta/Pinza Para Gutta

616
Self Lock
15 cm

615
Self Lock
15 cm

Paper Tweezer
Pinza Para Papel

1526
15 cm

1079

Elevators
Elevadors



Inox hollow light handle.
Mango en acero inoxidable hueco ligero.

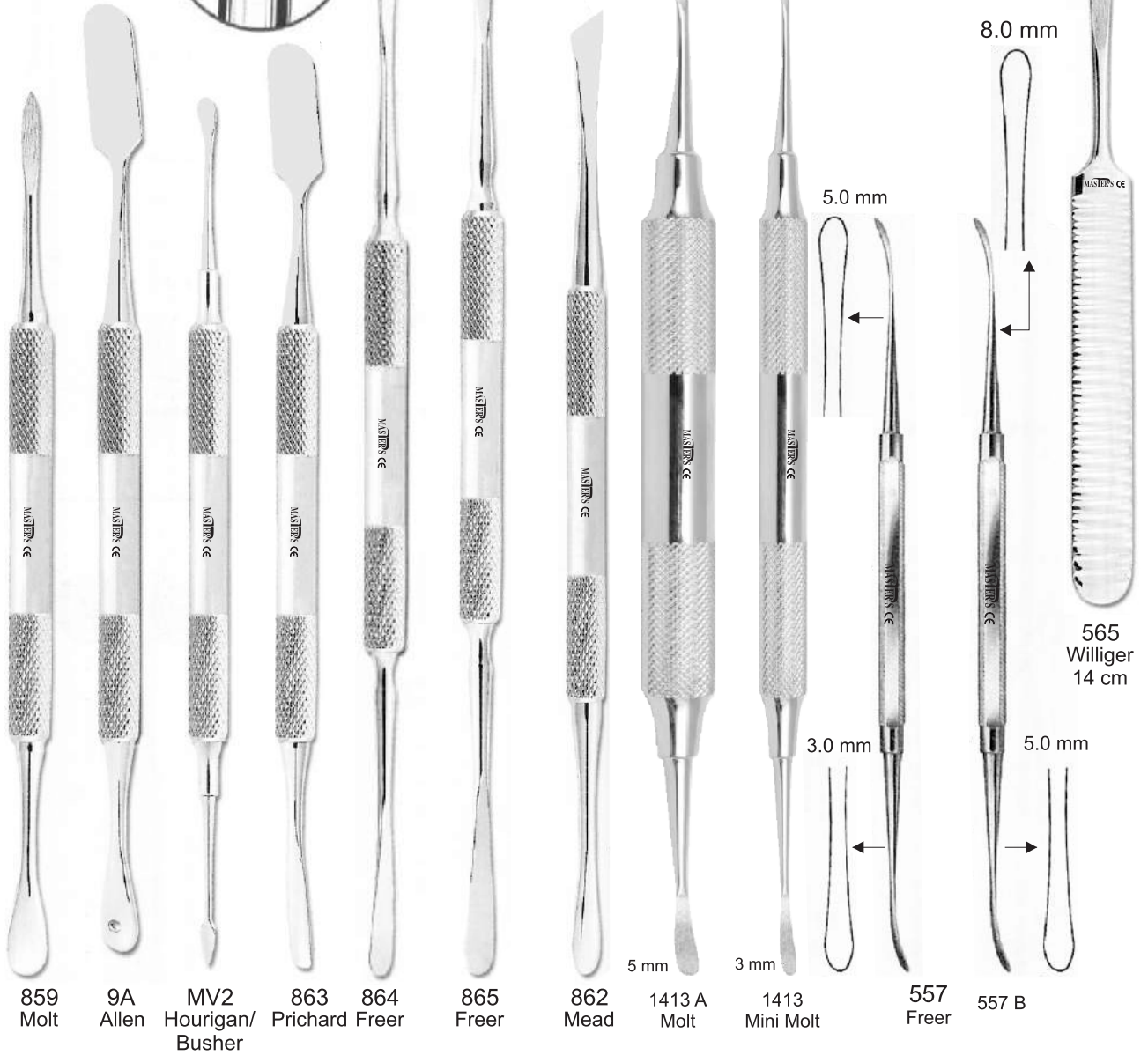

859 Molt 9A Allen MV2 Hourigan/ Busher 863 Prichard 864 Freer 865 Freer 862 Mead 5 mm 1413 A Molt 3 mm 1413 Mini Molt 5.0 mm 557 Freer 8.0 mm 557 B Williger 14 cm 3.0 mm 5.0 mm

Chisels / Cinceles



3mm → 1504 Wakefield
 5mm → 1503 Gardner
 1502 Ochsenbein
 1501A Ochsenbein



Amalgam Carriers
Porta Amalgama



1031
Small/Medium

1034
30°

1035
45°

1036
90°

Scalpel Handles
Mango de Bisturi

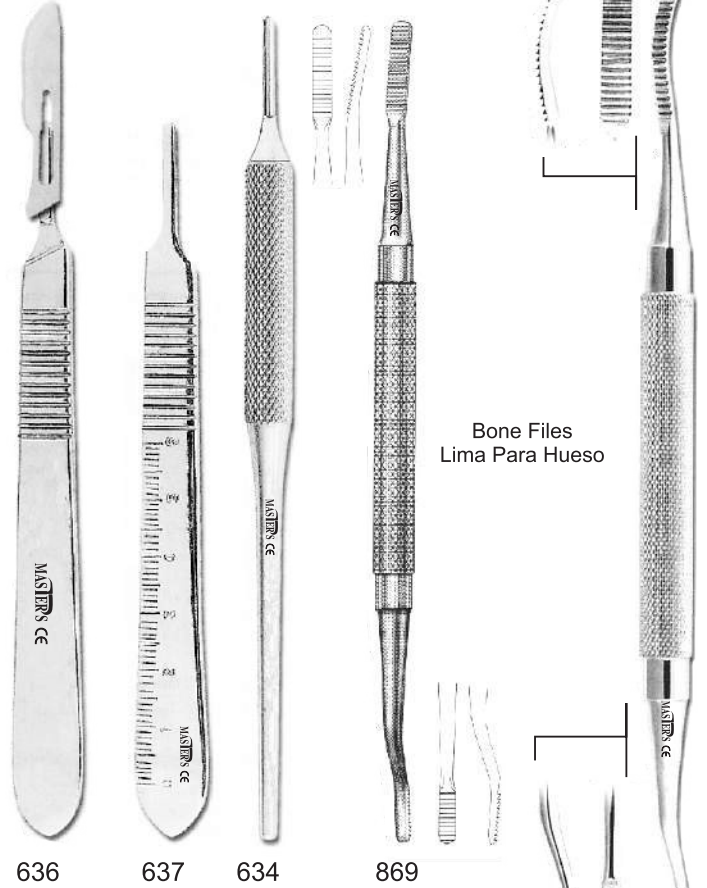

636

637

634

869

Bone Files
Lima Para Hueso

875

Mirror Handles | Mango Espejos

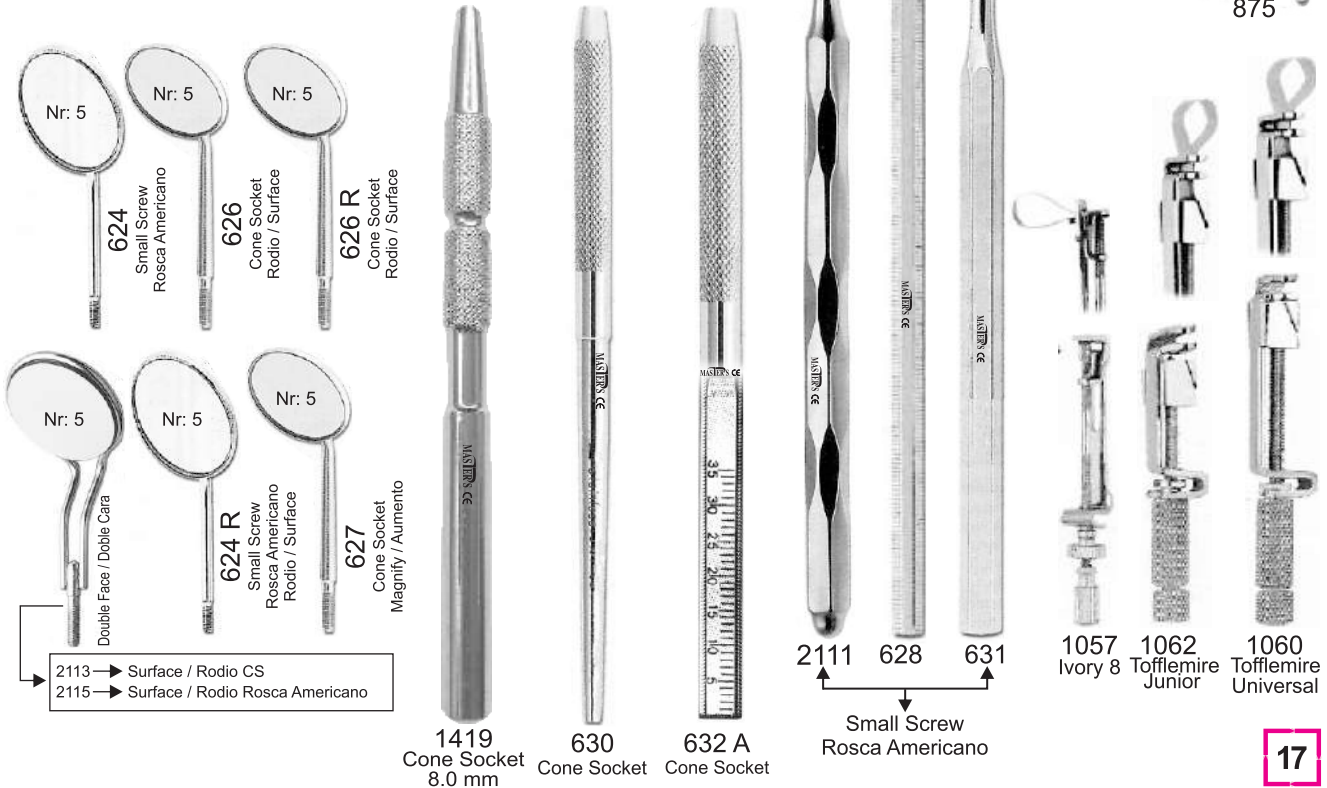

Nr: 5

Nr: 5

Nr: 5

624

Small Screw
Rosca Americano

626

Cone Socket
Rodio / Surface

626 R

Cone Socket
Rodio / Surface

Nr: 5

Nr: 5

Nr: 5

624 R

Small Screw
Rosca Americano
Rodio / Surface

627

Cone Socket
Magnify / Aumento

1419

Cone Socket
8.0 mm

630

632 A

Cone Socket

Cone Socket

2111

628

631

Small Screw
Rosca Americano

1057

Ivory 8

1062

Tofflemire
Junior

1060

Tofflemire
Universal



Explorers (Single)
Sondas (Sencilla)

Explorers (Double)
Sondas (Doble)

Explorers (Endodontic)
Sondas (Calibradas)

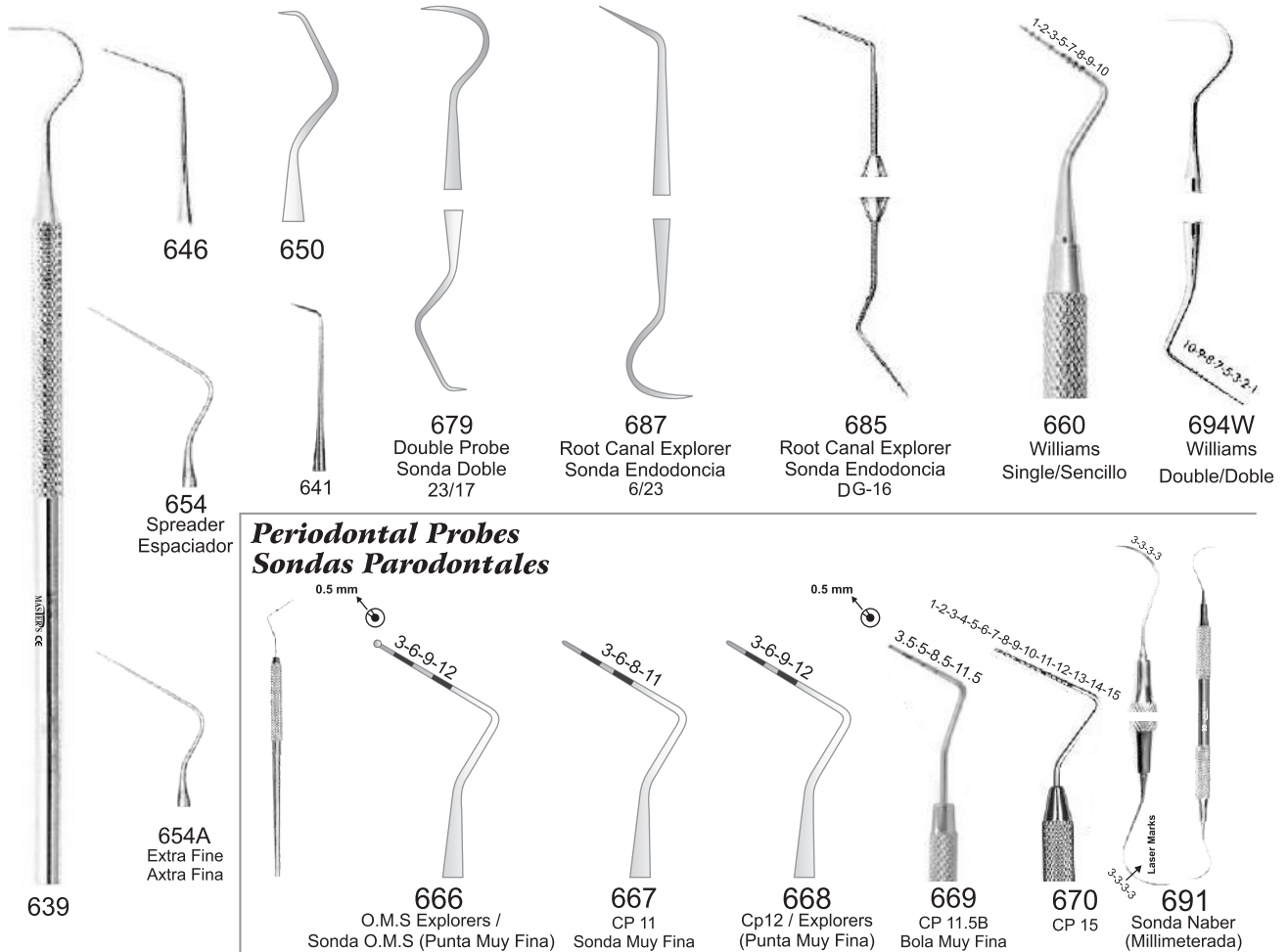

Filling Instruments / Bruñidores y Atacadores

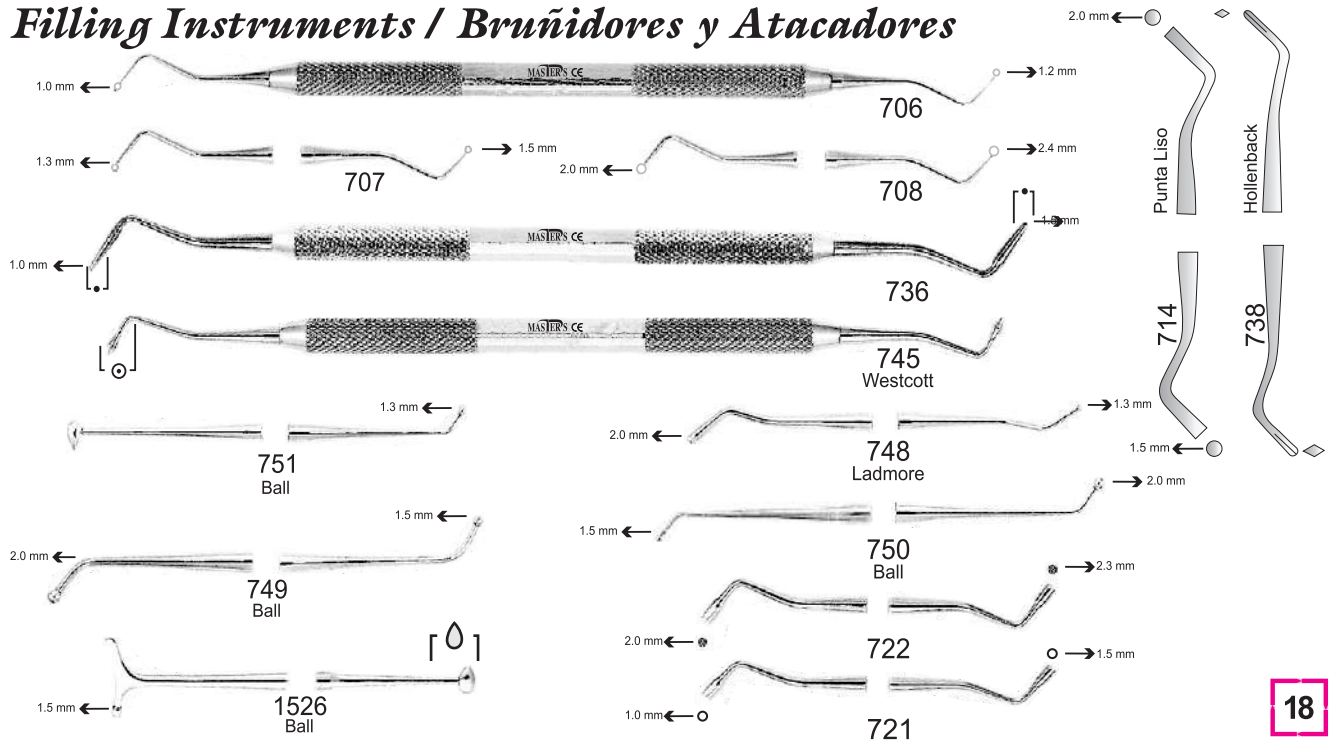

Bone Currettes / Cucharillas Alveolares

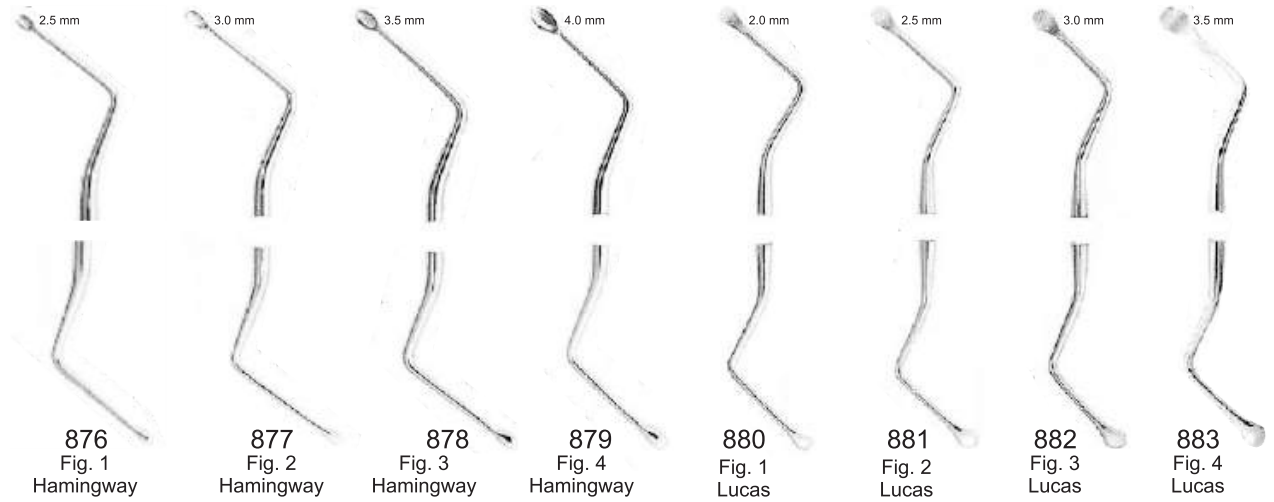

Bone Currettes / Curtas, Cinceles y Obturaciones Plsticas

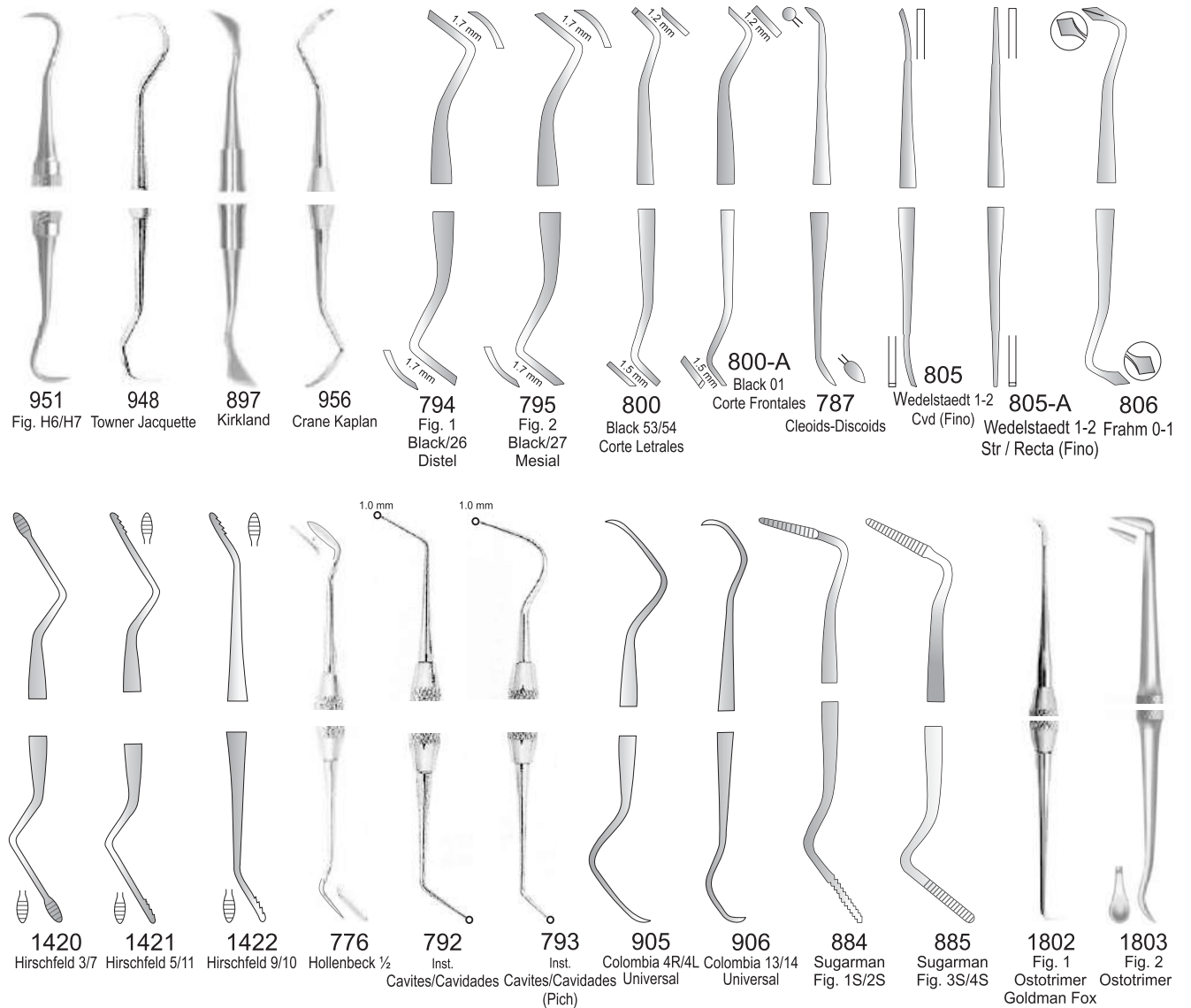



Excavators

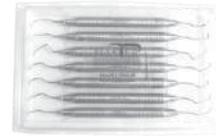
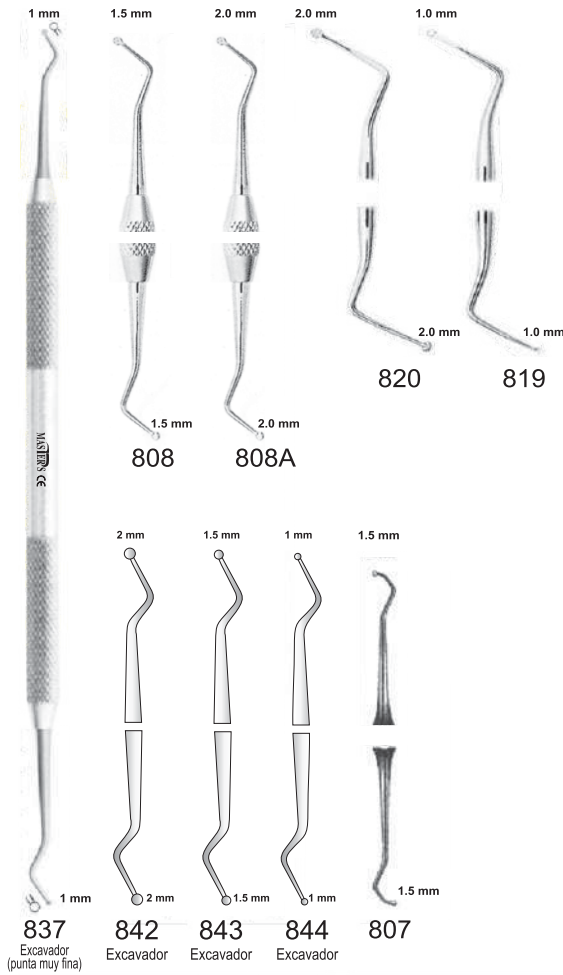

025-280-T
Titanium Coted Gracy
Hallow Handle 9.5 mm

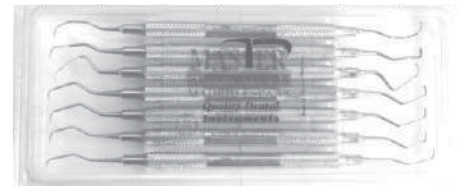
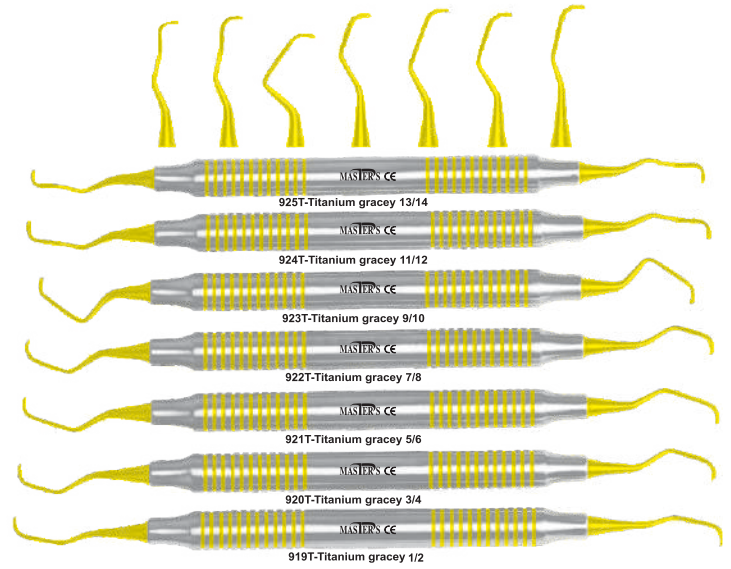

025-280-S (Handle 8mm)

OVAL SPOON



Explorer Kit



025-280F
Gracey Mini Five
Set of 7

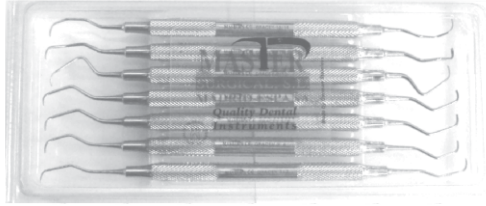

919F Gracey Mini Five 1-2
 920F Gracey Mini Five 3-4
 921F Gracey Mini Five 5-6
 922F Gracey Mini Five 7-8
 923F Gracey Mini Five 9-10
 924F Gracey Mini Five 11-12
 925F Gracey Mini Five 13-14

Instruments for Threads
Instrumentos para Hilo

New

Dentadas

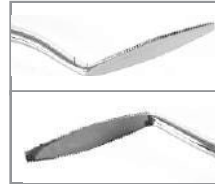

1401 1402

Dentadas



Dental Micro Extraction instrument kit



- 2307 (2.55 mm) Recta
- 2306 (1.5 mm) Recta
- 2305 (2.60 mm) Curva
- 2304 (2.65 mm) Angulo/Bayonta
- 2303 (3.70 mm) Angulo/Bayonta
- 2302 (2.75 mm) Curva
- 2301 (3.60 mm) Angulo/Bayonta



2300 (Kit Complete) 07-pcs/uni

Gutta Percha Plugger

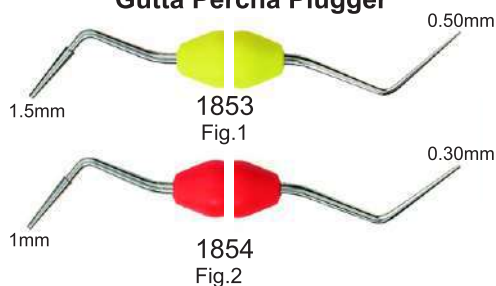

Heat Carrier Plugger

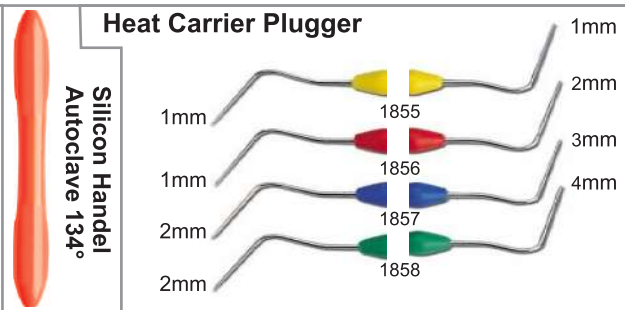

Cement Spatulas
Espatulas Para Cemento

Espatulas Para Composite

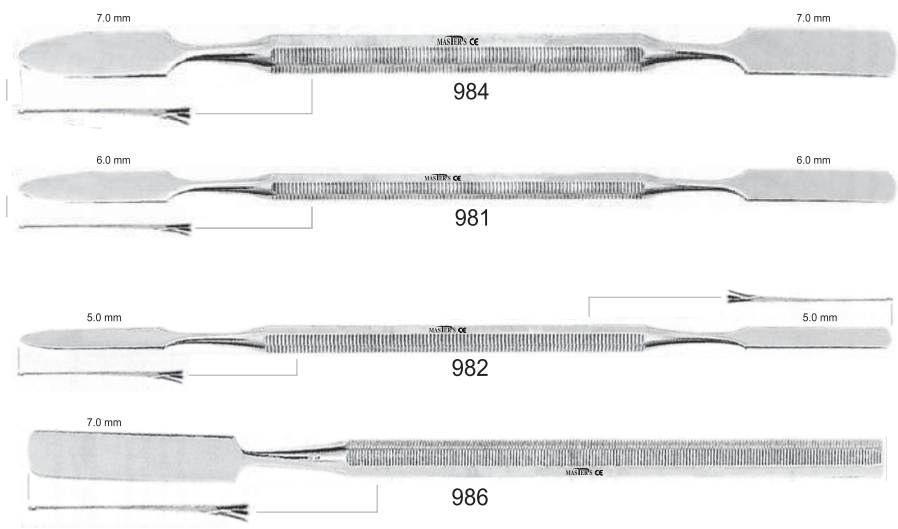
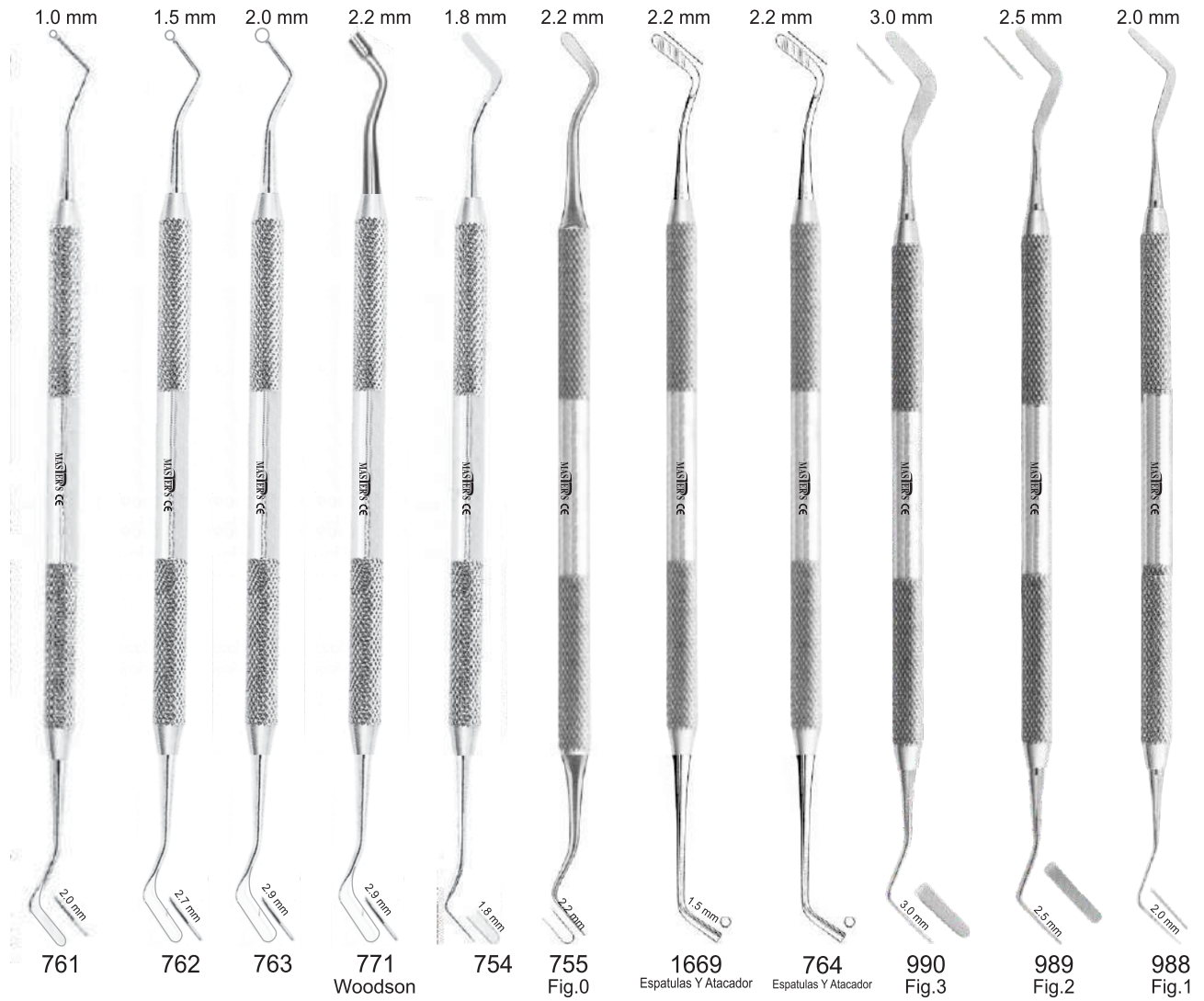

Espatulas Para Composite

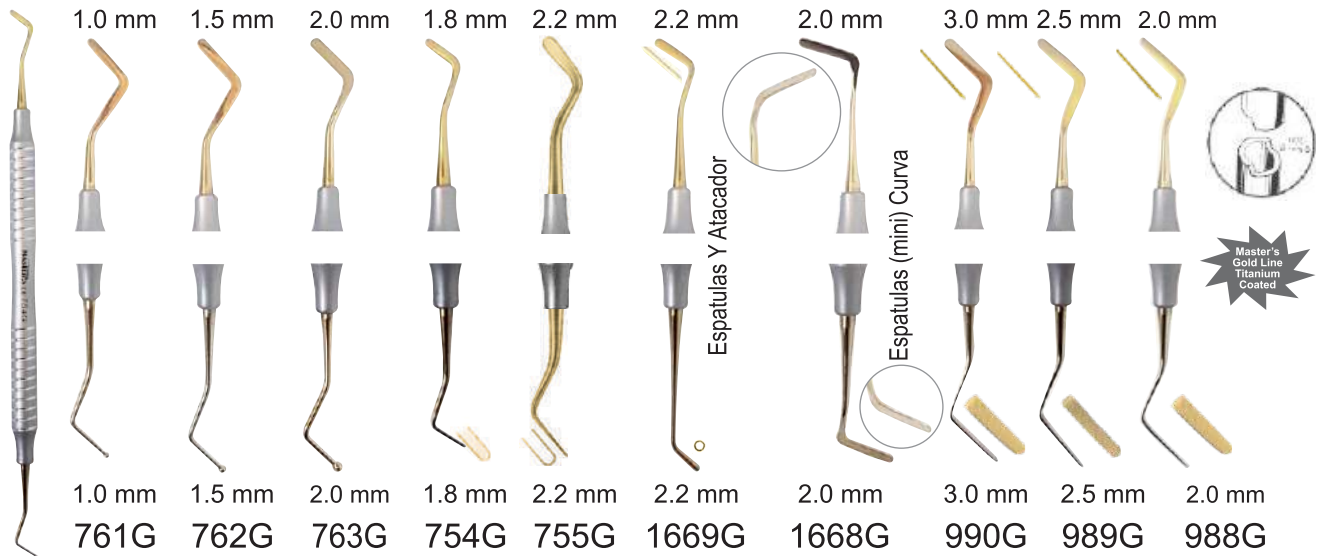

Filling Instruments / Bruñidores y Atacadores

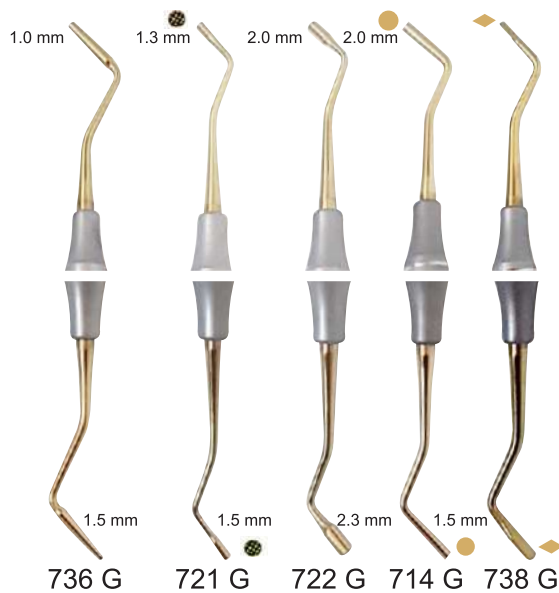
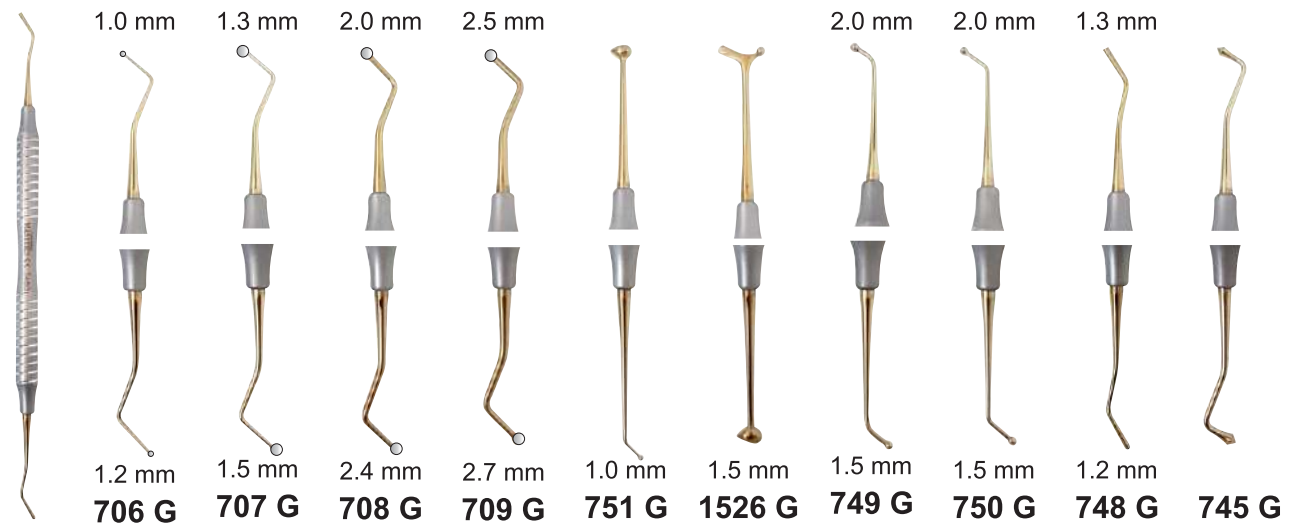



Bone Currettes / Cucharillas Alveolares

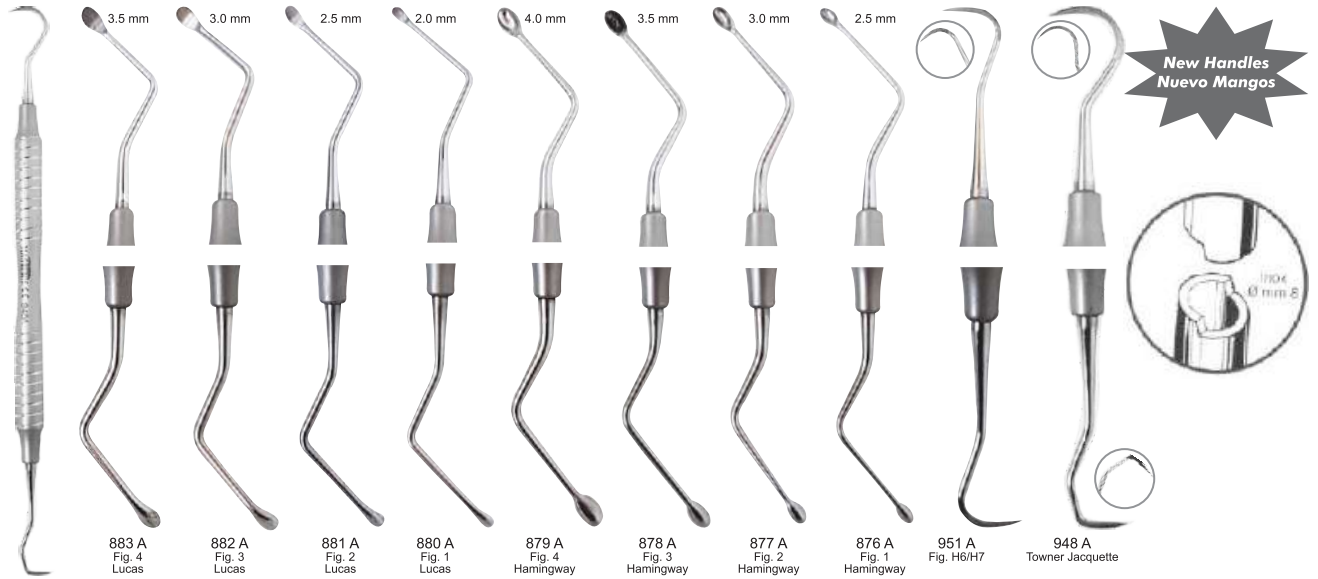

883 A Fig. 4 Lucas 882 A Fig. 3 Lucas 881 A Fig. 2 Lucas 880 A Fig. 1 Lucas 879 A Fig. 4 Hamingway 878 A Fig. 3 Hamingway 877 A Fig. 2 Hamingway 876 A Fig. 1 Hamingway 951 A Fig. H6/H7 948 A Towner Jacquette

Excavators / Exavadores / Cucharillas

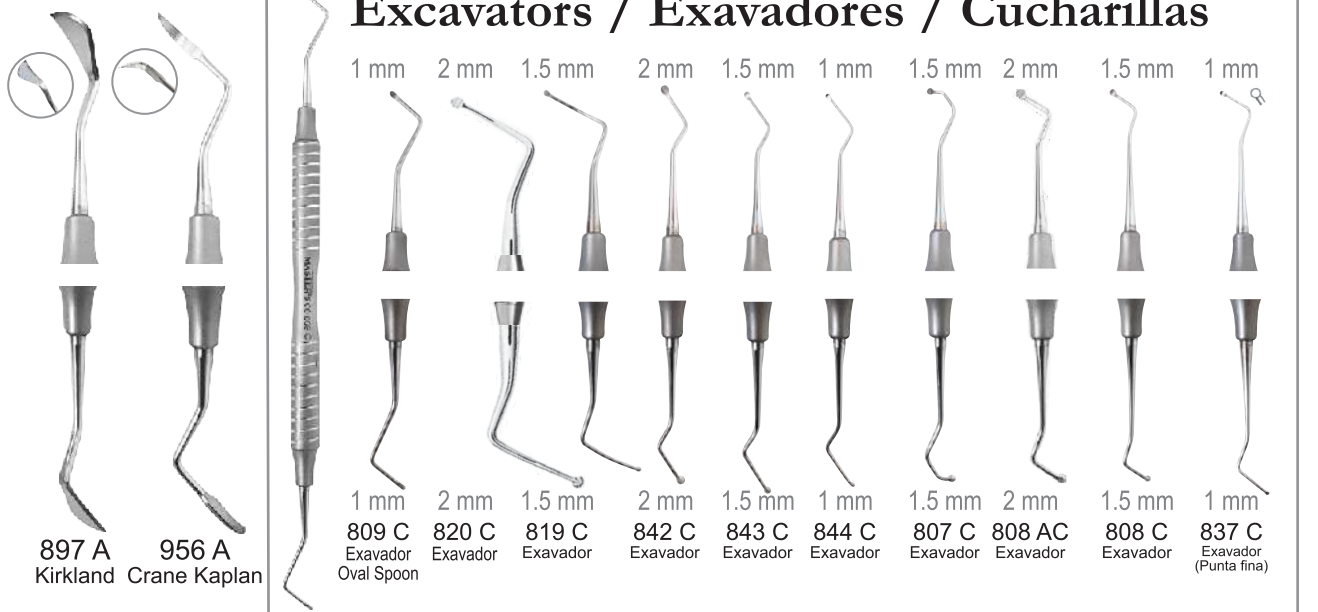

897 A Kirkland 956 A Crane Kaplan 809 C Exavador Oval Spoon 820 C Exavador 819 C Exavador 842 C Exavador 843 C Exavador 844 C Exavador 807 C Exavador 808 AC Exavador 808 C Exavador 837 C Exavador (Punta fina)

Curet Lucas (saw edge) / Cureta Lucas (Dentada)

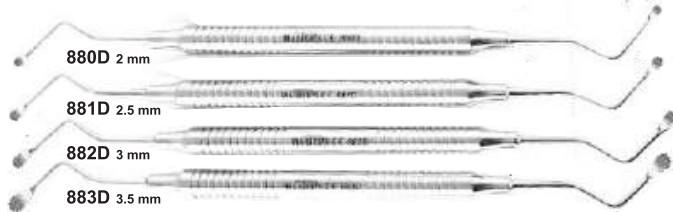

Explorers Single / Double Sondas Sencil a/ Doble

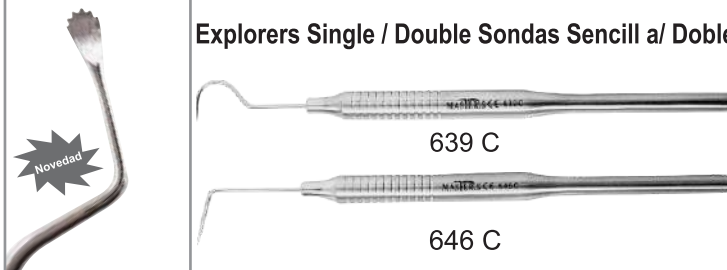

Novedad

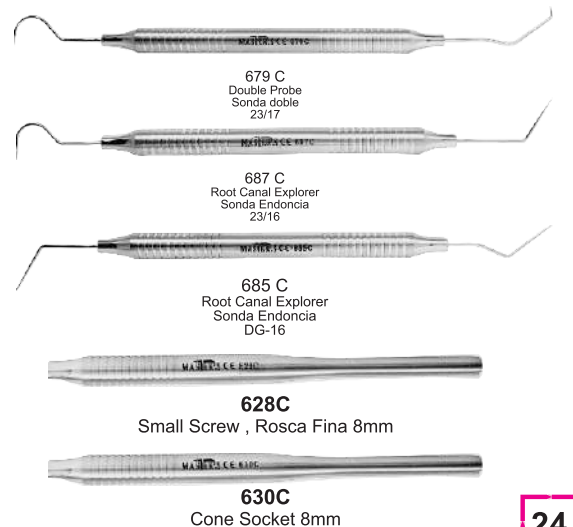



Silicone Handle / Mango De Silicona

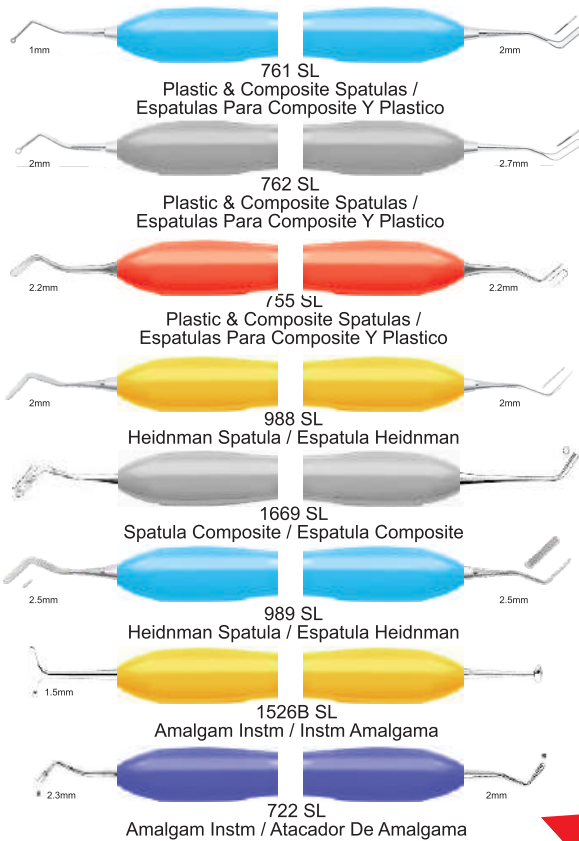
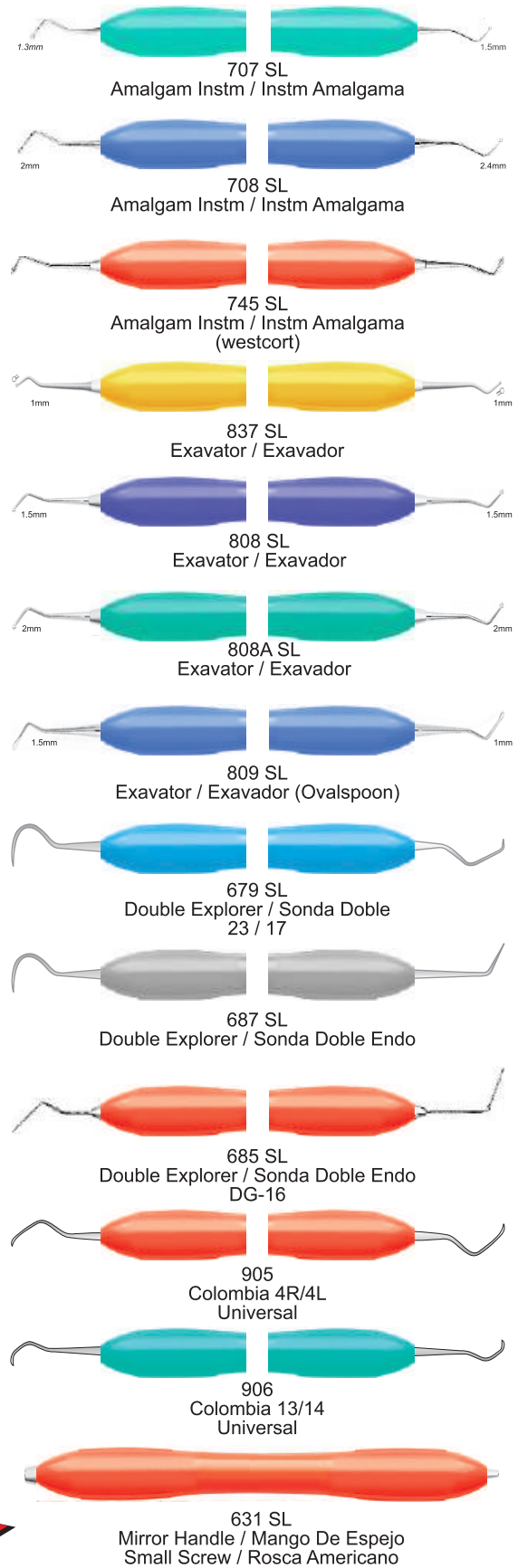
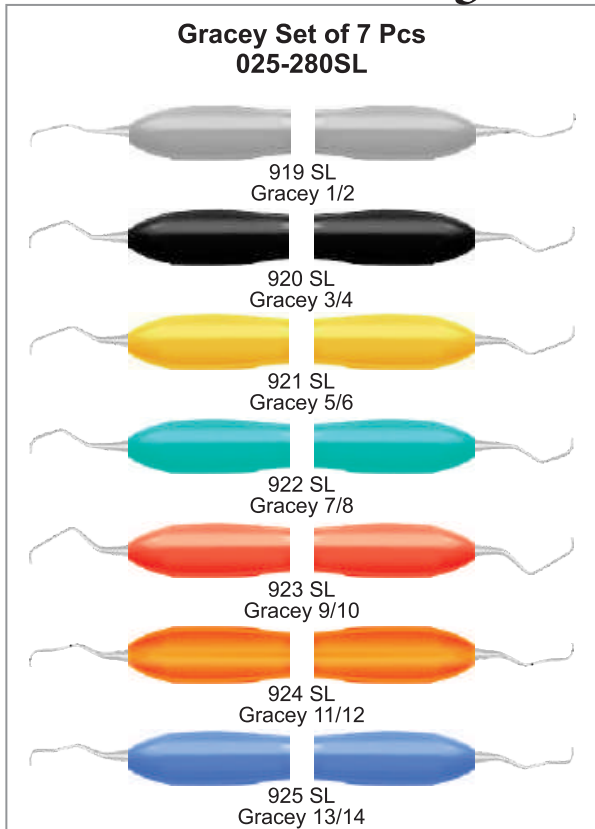



Wax & Modelling Carvers
Instrumentos Para Cera Y Modelar

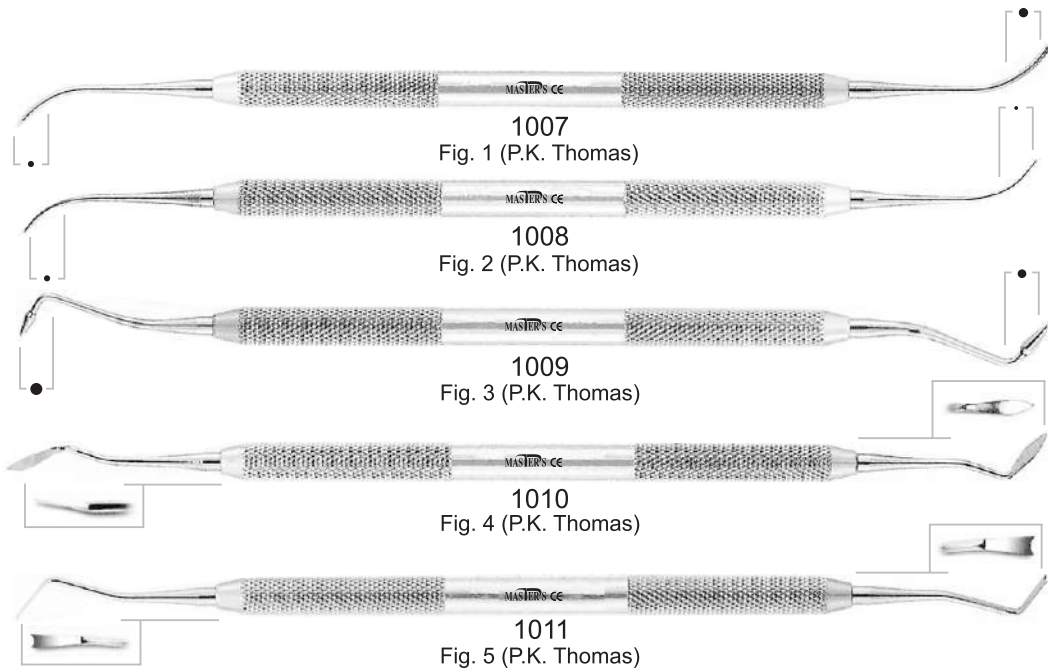
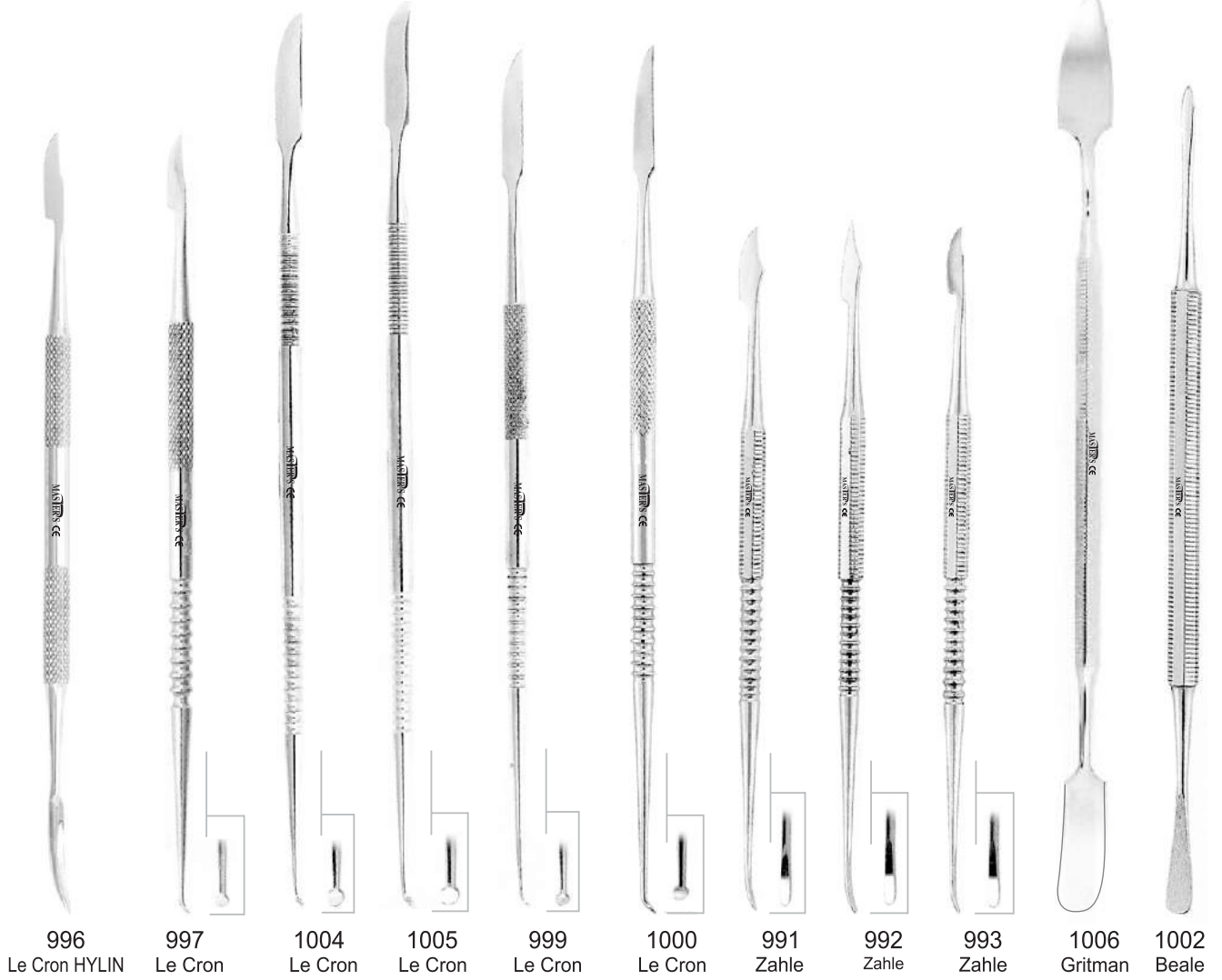



Wax & Modelling Carvers
Instrumentos Para Cera Y Modelar



1527
Laboratory Tweezer

1528
Laboratory Tweezer



1012
Fahenstock
12.5 cm



1015
Fahenstock
17 cm



1013
Fahenstock
12.5 cm



1016
Fahenstock
17 cm



1018
17 cm



Plastic Handle/Mango Plastico

1025
20.5 cm
Alginato



1022
20.5 cm
Escayola



1026
18.5 cm
Espatula Alginato
Plastico Duro
Color Disponible / Azul / Rosa / Blanco

1020
19.5 cm

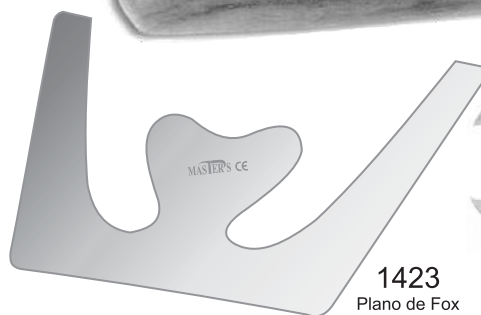

1423
Plano de Fox
Plastic / Plastico

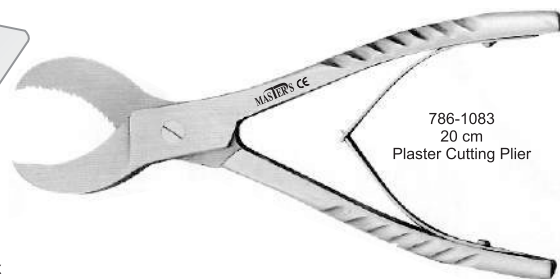

786-1083
20 cm
Plaster Cutting Plier

Laboratory Instruments
Instrumentos Para Laboraorio



1074
Boley
14 cm
Pie de Rey



1071
Iwanson
(For Wax)



1070
Iwanson
(For Metal)



1067 (Str)
10.5 cm

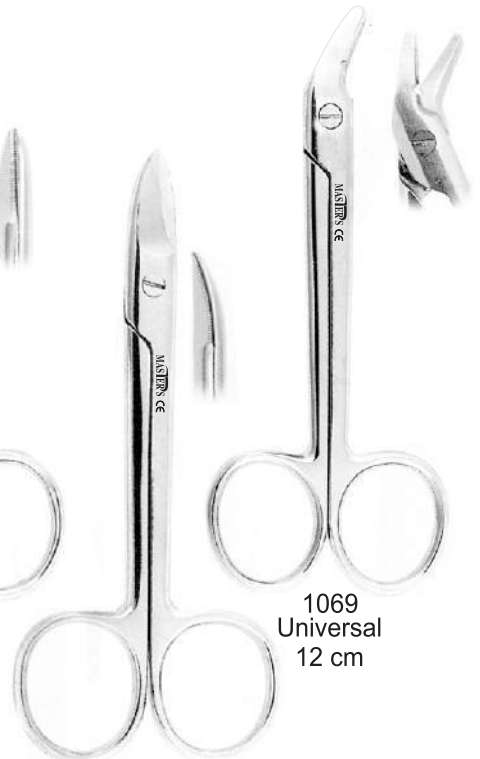

1069
Universal
12 cm



1068 (Curved)
10.5 cm

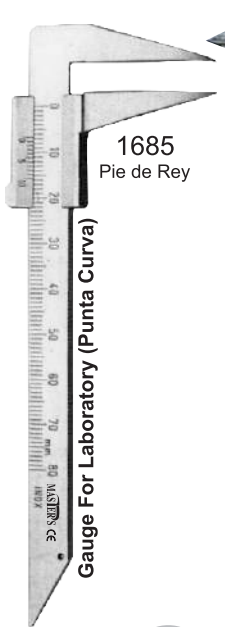

1685
Pie de Rey
Gauge For Laboratory (Punta Curva)



2204
Pie de Rey
Gauge For Laboratory (Punta Doble Curva)



1131 B
Medium/Mediano
Universal (R/L)
(izd/drha)



1129
Parcial (L)



1130
Parcial (R)



028
Articulator Full Arch
Chrome Plated



1131
Small/Peq
Universal (R/L)
(izd/drha)

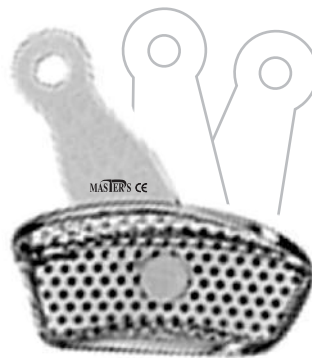

1131 A
Medium/Mediano
Universal (R/L)
(izd/drha)



1127
U1P



1127
L1P



**Impression Trays (Rimlock)
 Cubetas en Acero (Rimlock)**

**Solid Partial Set of 10
 225-001S**

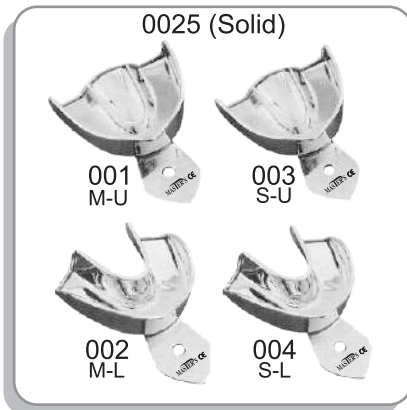
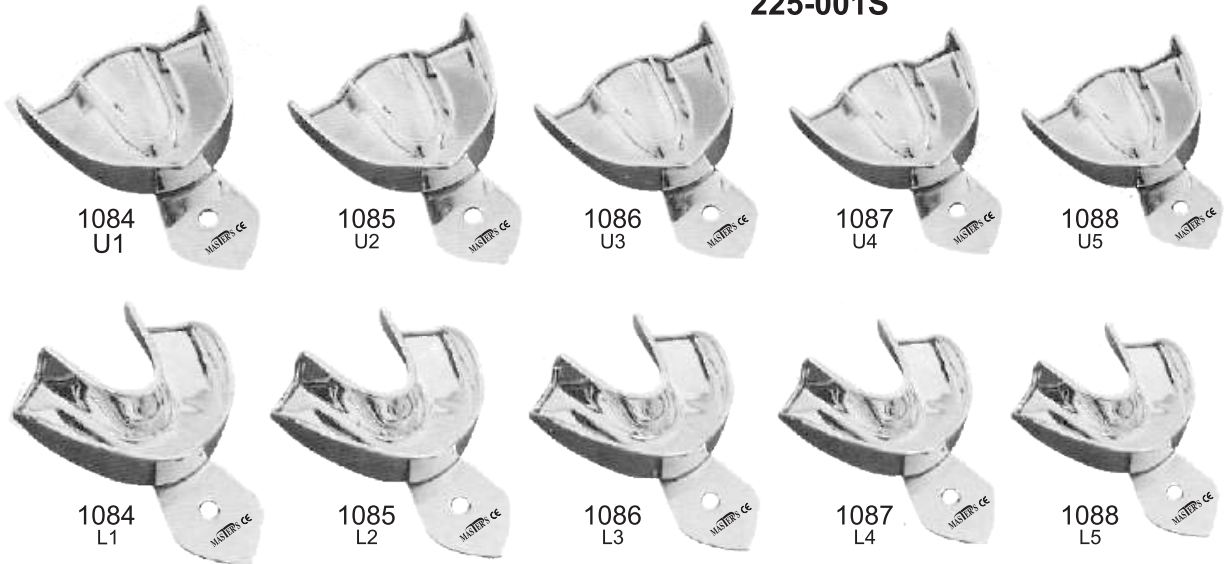

**Set For Children
 Cubetas para niños**

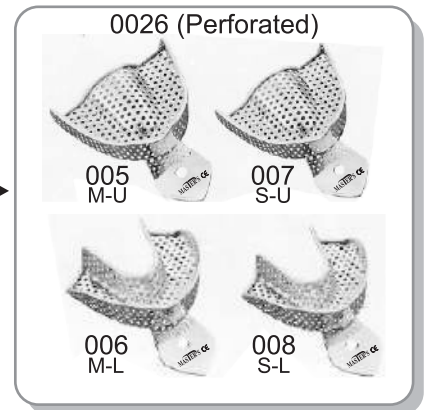

**Perforated Partial Set of 10
 225-010S**

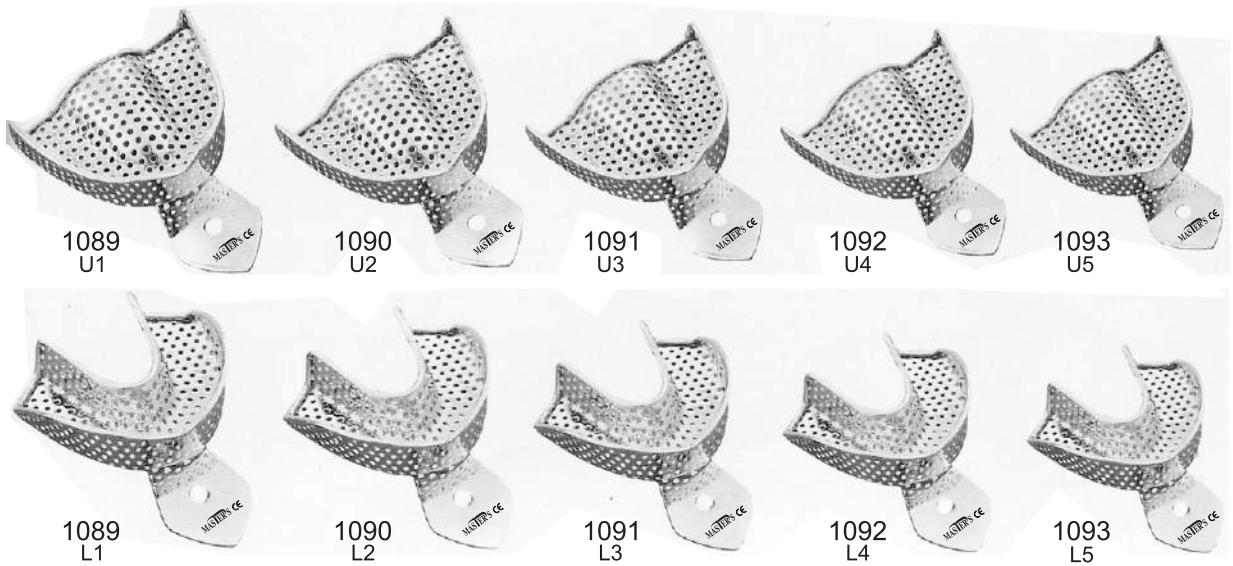



Impression Trays (Rimlock)
Cubetas en Acero (Rimlock)

Solid Full Denture Set of 8
225-011S



1094
U-XL

1095
U-L

1096
U-M

1097
U-S

1094
L-XL

1095
L-L

1096
L-M

1097
L-S

Perforated Full Denture Set of 8
225-018S

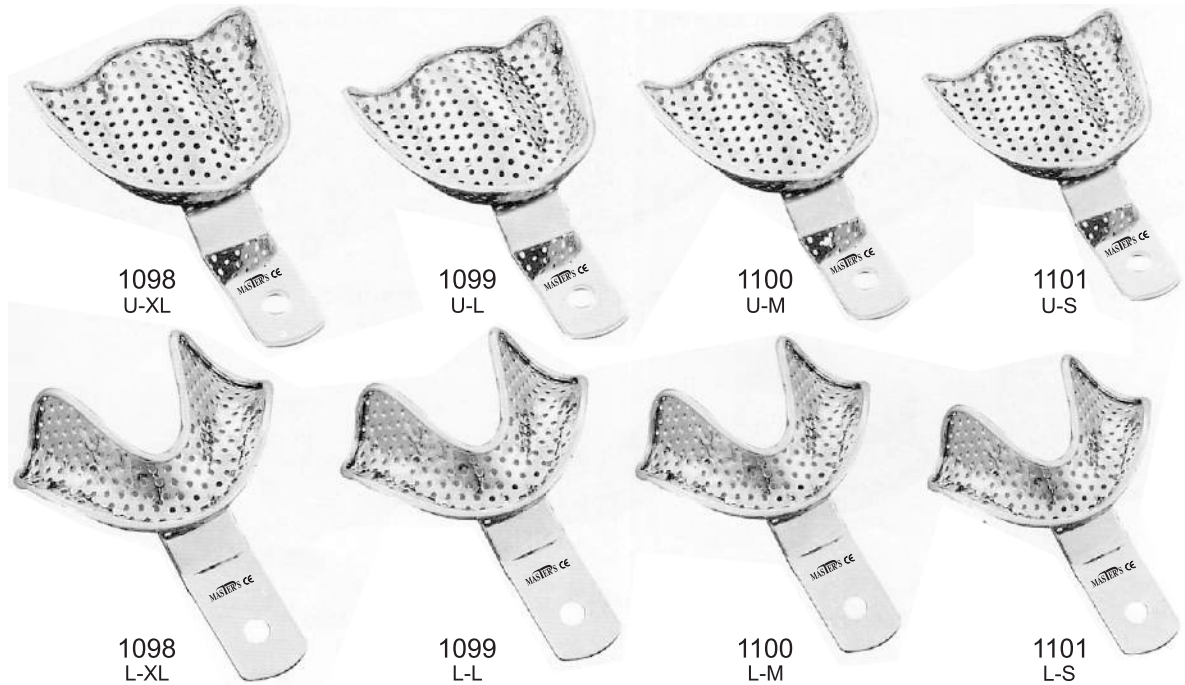

1098
U-XL

1099
U-L

1100
U-M

1101
U-S

1098
L-XL

1099
L-L

1100
L-M

1101
L-S

Impression Trays "Easy Open" (inox)
Cubetas Impression "Easy Open" (inox)

225-012
 Set of 10 pcs / Juego de 10 unid

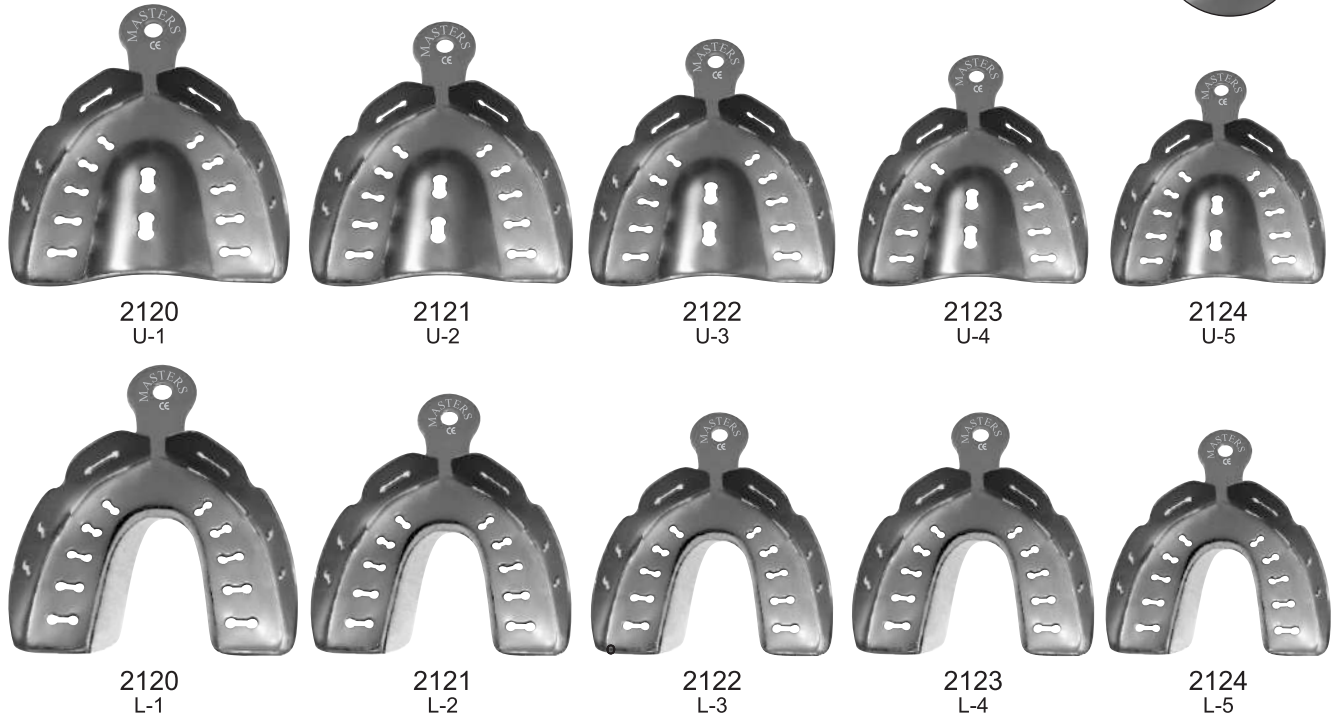
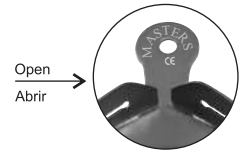

Impression Trays "Easy Open" (inox)
Cubetas Impression "Easy Open" (inox)

225-013
 Set of 06 pcs / Juego de 06 unid

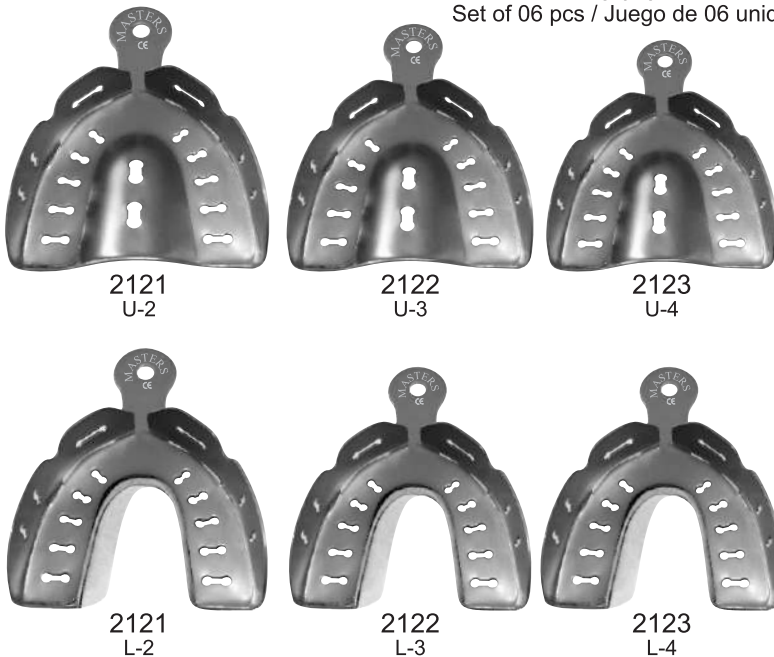

225-014S
 Set of 06 pcs / Juego de 06 unid





*Rubber dam kit/
Kit dique de goma*



Sup.

1549
2 Pieces Set
Juego 2 Unids
Rubber/Goma



Inf.

1560
Zocaladores Ortodoncia
Rubber/Goma



2220
Student kit
10-pcs



1550
Lingotera
Rubber/Goma



2221
Student kit
24-pcs



1551
Rubber Bowl 140 mm
Taza Escayola



2222
Student kit
20-pcs



1561
Taza alginato
Rubber Bowl 130 mm

**Rubber dam kit/
Kit dique de goma**



1552
 Clamps Nos: 0, 2, 2A, 7, 8A, 9, 14, 14A



1441
 Dental Clamps Holder (inox)
 Fresero Para Clamps
 117x61x10 mm

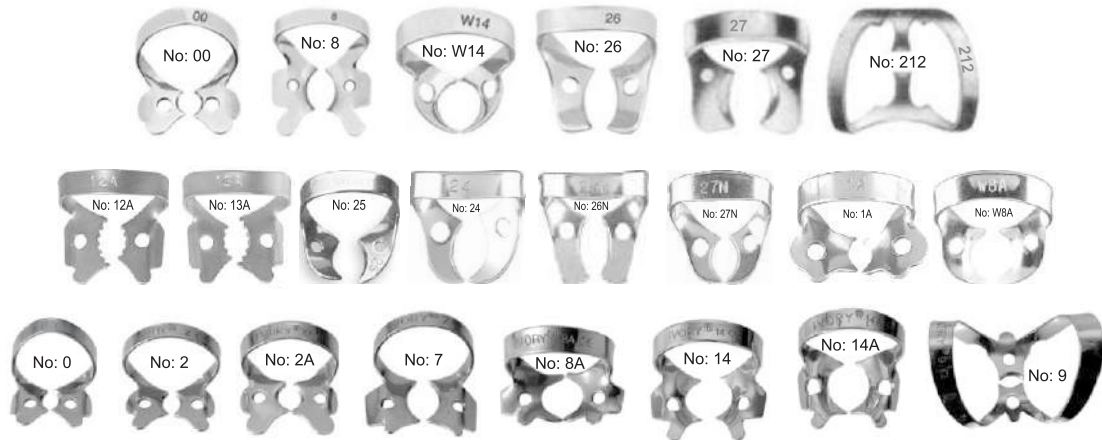

**Rubber
Dam Items**

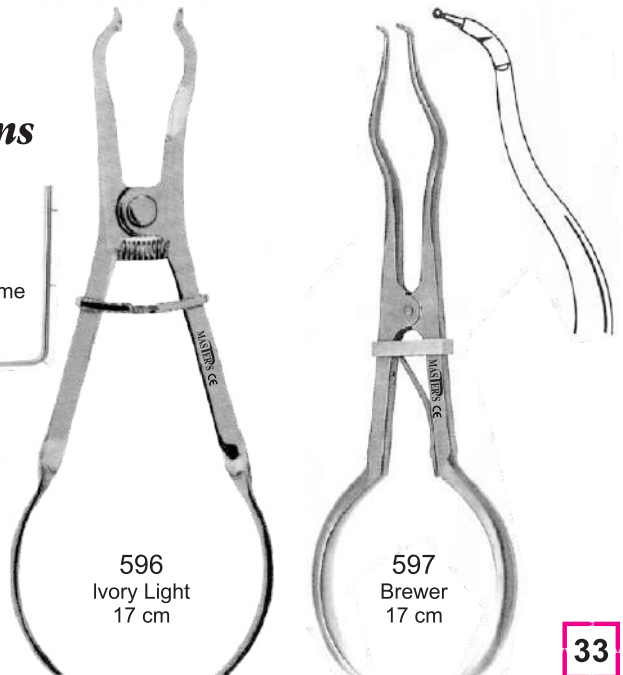
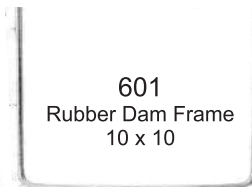
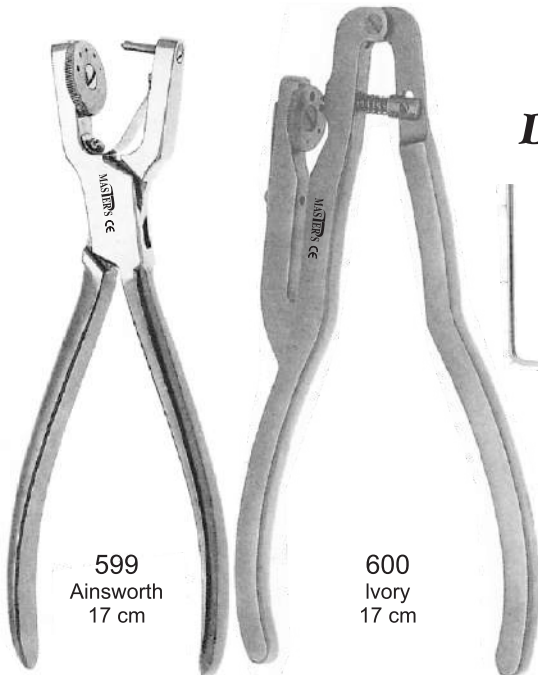

Orthodontic Instruments
Instrumentos Para Ortondoncia

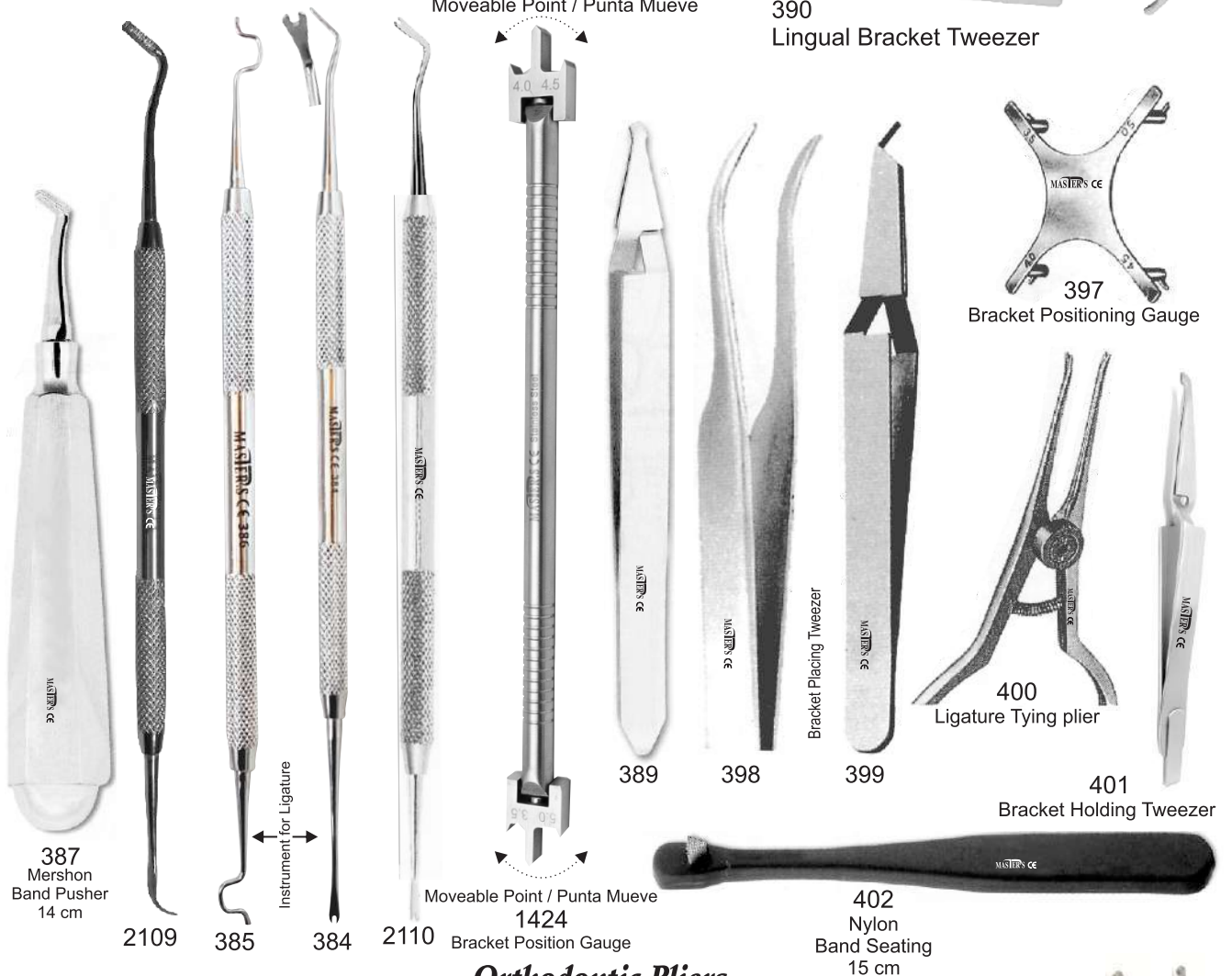

Orthodontic Pliers
Alicates Para Ortondoncia Y Protesis

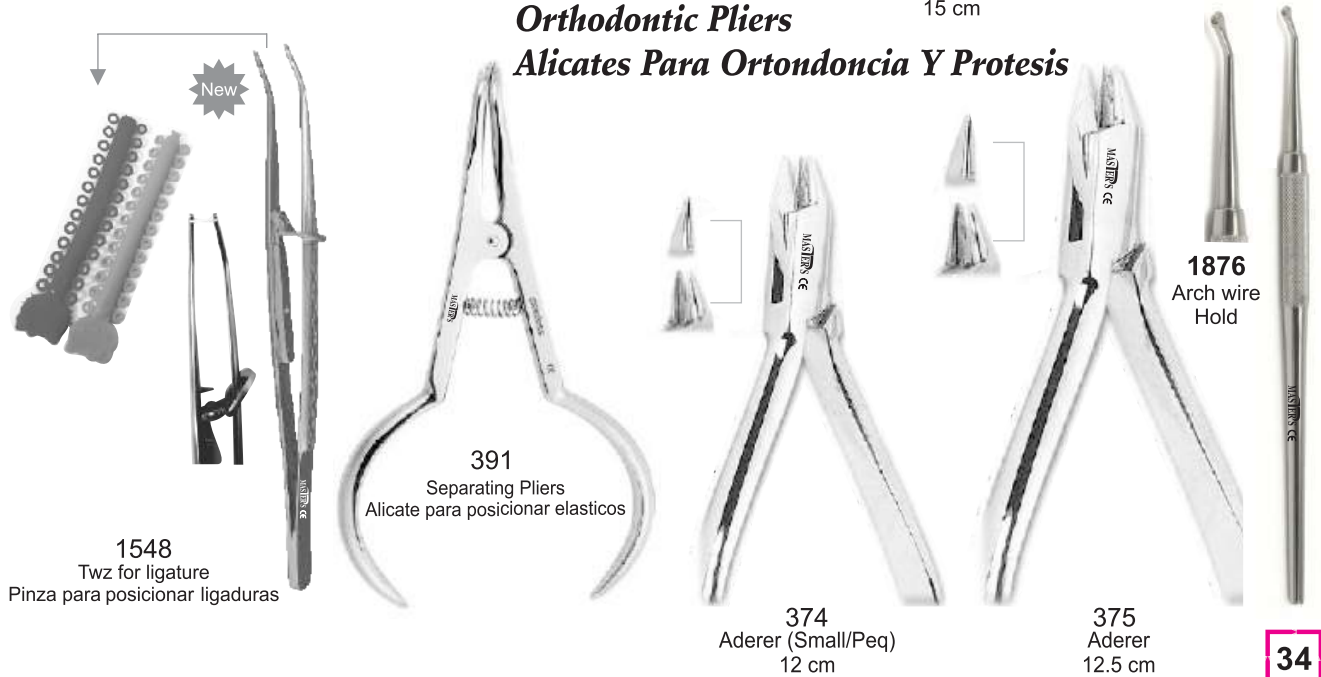



Orthodontic Pliers
Alicates Para Ortodoncia Y Protesis



381
Young
14 cm



1530
Johnson
12 cm



1531
Nance
12 cm



1533
Atkinson
13 cm

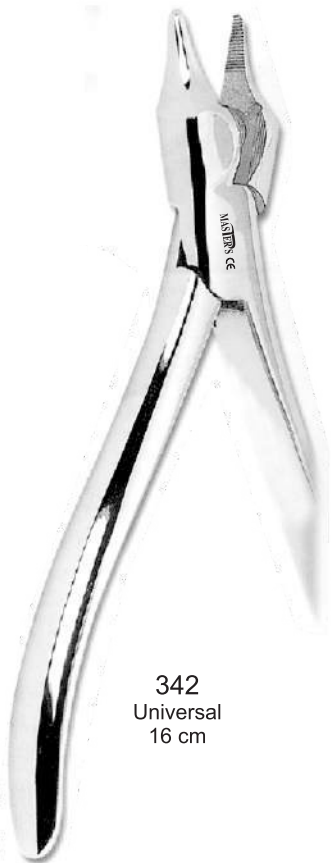

342
Universal
16 cm



341
Waldsachs
15 cm

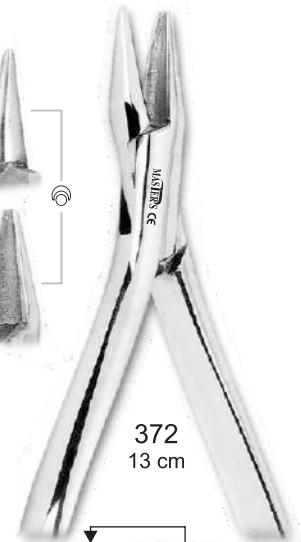

372
13 cm

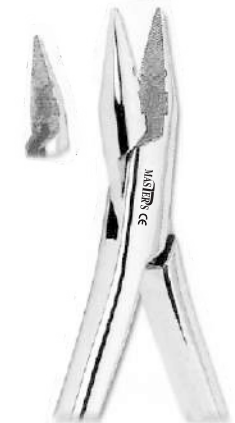

1532
Universal
16 cm



1534-A
De La Rosa (Punta Lisa)
13 cm



1534
De La Rosa
13 cm



Orthodontic Pliers Alicates Para Ortodoncia Y Protesis

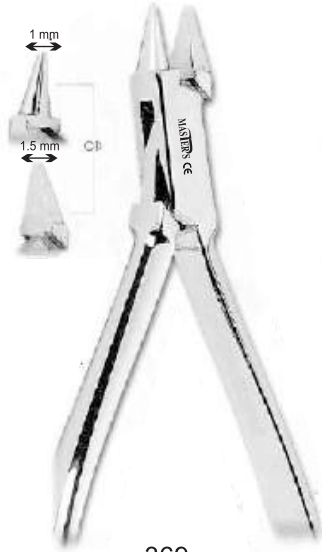

369
Angle
12 cm

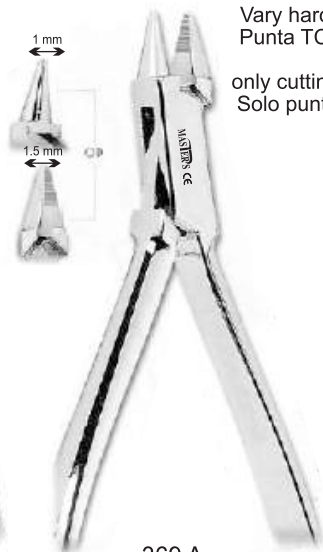

369 A
Angle with Point Marked
12 cm



369 B
Angle with Cutting Edge
O Maximum wire 0.05 mm



379
Adams
12 cm



359
How (Angled)
14 cm



358
How
14 cm

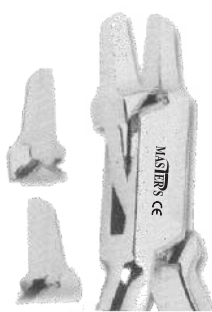

380
Tweed Frevert
13 cm



1684
Renold
13 cm



376
Tweed
14 cm

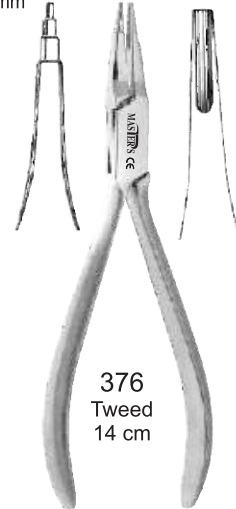

376 A
Tweed Small Pequeño



369 T
Angel Plier (TC)
12 cm



"V" form/
"V" forma



1428
"V" Shaped Plier
13 cm













1427
Tweed 13 cm



373
Nose Plier Bimler
13 cm



Orthodontic Pliers
Alicates Para Ortondoncia Y Protesis

 1535 Band Removing Plier 13 cm	 1536 Band Removing Plier 13 cm	 1537 Bracket Removing Plier Str / Recta (13 cm)	 1425 Bracket Removing Plier Cvd (13 cm)		
 1540 Weingart (TC) Utility Plier 13 cm	 1541 (Standard) TC Ligature Cutting Plier Only use soft wire Maximum .012"(.30mm) 13 cm	 1400 (Micro) TC Ligature Cutting Plier Only use soft wire Maximum .012"(.30mm) 12.5 cm	 1538 Distal End Cutter (TC) Max 0.5 mm (.021x.025") 0.41 x 56 mm (.016" x .022") 13 cm		
 2205 Band Remove Teflon Tips Bag of 5pcs Puntas Teflon Quita banda Bolsa de 5 unid	 1539 Hard Wire Cutter (TC) Max 0.7 mm (.020") 0.41 x 56 mm (.016" x .022") 13 cm	 1811 Arch Wire Cutter (TC) .012", .014", .016" Only / Solo Max 0.14x0.25", 0.16x0.16", 0.16x0.22" Only / Solo Max 13 cm	 1812 Lingual Ligature Cut Plier(TC) Only use soft wire Maximum .012" (15 cm)	 1813 Lingual Ligature Cut Plier(TC) Only use soft wire Maximum .012" (15 cm)	 2117 Heavy Wire Cutter Triple (TC) Max 2.0 mm



Orthodontic Pliers / Alicates para ortodoncia

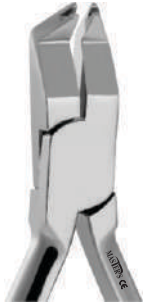

2006
Crimp Pliers
13 cm

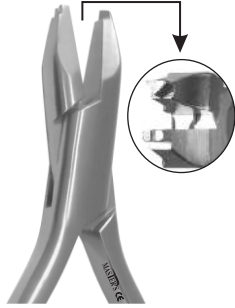

2007
Crimp Pliers
13 cm



2009
Flash Cut Pliers
(max 0.03 mm)
13 cm



2010
Flash Cut Pliers
(max 0.05 mm)
13 cm



2011
Step Pliers (Tc)
Wire bending 1mm
13 cm



2011 A
Step Pliers (Tc)
Wire bending 0.50mm
13 cm

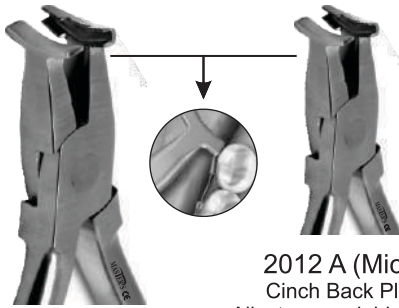

2012
Cinch Back Pliers
Alicate para doblar arcos
13cm (Standard)

2012 A (Micro)
Cinch Back Pliers
Alicate para doblar arcos
13cm



2013
Torquut Pliers (Male)
13 cm



2014
Torquut Pliers (Female)
13 cm



2008
Flash Cut Pliers
(Universal)
13 cm

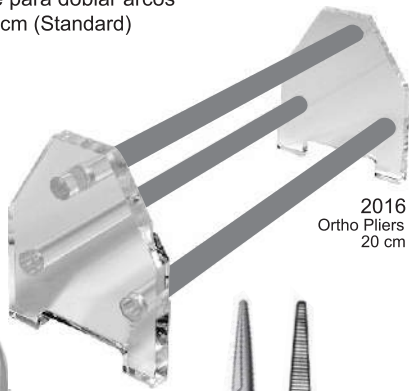

2016
Ortho Pliers stand
20 cm



1877
Arch Wire Bending



2001
Tewzeer for tubes/
pinza para tubos



465
Mathieu
Fine/Fino
for ligature plastic /
para ligadura plastico



0050
Mathieu (Curved)
for ligature plastic /
para ligadura plastico

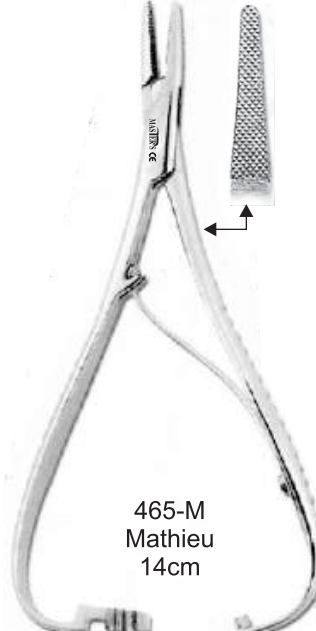

465-M
Mathieu
14cm
for Ligature Metal /
para ligadura metalico



465 (TC)
Mathieu (fine/ fino)
14 cm
Universal Use for
Needle Holder / Ligature Metal & Plastic
Uso universal para
porta aguja / ligadura metalico Y platico



Stainless Steel Wire Tubes/
Varilla de acero en tubos
10 pcs /10 unid

Rectangular Wire	
Ref. Nos.	Sizes
072	16 x 16 "
073	16 x 22 "

Round Wire	
Ref. Nos.	Sizes
071	0.3 mm
060	0.4 mm
061	0.7 mm
062	0.8 mm
063	0.9 mm
064	1.0 mm



2312
Vertical Hole Cutter
13 cm



0.9mm 50g
MASTER'S CE

Novedad

Round Wire	
Ref. Nos.	Sizes
074	0.6 mm
075	0.7 mm
076	0.8 mm
077	0.9 mm

Novedad
Alineador Ortodoncia Alicates



2313
Key Hole Cutter
13 cm



2314
Rectangular Cutter
13 cm



2311
Circle Big Cutter
13 cm



2310
Circle Small Cutter
13 cm

<p>Plastico</p>  <p>2095 A Rubber Dam Frame Plastic (Autoclavable)</p>	<p>Plastico</p>  <p>2096 A Rubber Dam Frame Plastic (Autoclavable)</p>	<p>Eyes Protection Goggles Gafas Para Proteccion</p> <p>Plastico</p>  <p>Color Disponible Transparente, Naraja,</p> <p>2097-A</p>	
<p>Plastico</p>  <p>2098 Burs Holder / Fresero 24 Holes for FG Handle (Autoclavable)</p>	<p>Plastico</p>  <p>2099 Burs Holder / Fresero 10 Holes for FG Handle 50 Holes RA Handle (Autoclavable)</p>	<p>Glass / Cristal</p>  <p>2100 Dappen Dishes / Vaso Dappen</p>	
<p>Plastico</p>  <p>2101 Endo File Box Aluminum 118x83x50mm (Autoclavable)</p> <p>Colour Available / Color Desponible: Blue & Red / Azul y Rojo</p>	<p>Plastico</p>  <p>2102 Endo File Holder 155x60x35mm (Autoclavable)</p>	<p>Plastico</p>  <p>2103 Endo File Holder 10x2.4x3.2cm (Autoclavable)</p>	
<p>"O" Style Cheek Retractors Abre boca tipo "O"</p> <p>Plastico</p>  <p>2104 (No Autoclavable)</p>	<p>Plastico</p>  <p>2105 Cheek Retractors Abre Boca (Autoclavable) Kit de 2 unid / Kit of 2 pcs</p> <p>Child / Niño</p> <p>Adult / Adulto</p>	<p>2112 B Adult / Adulto</p>  <p>2112 Child / Niño</p> <p>Cheek Retractors Abre Boca (Autoclavable) Kit de 2 unid / Kit of 2 pcs</p>	
<p>Mirror Photographic (Surface) Espejos Fotografia (Rodio)</p> <p>Glass / Cristal Double Face / Doble Cara</p>  <p>3051 → Espejos Linguales (A) XL 131mm largo y 66 mm ancho 3052 → Espejos Linguales (B) NIÑO 81 mm largo y 54 mm ancho 3053 → Espejos Linguales (C) Bucal 145x38x41mm 3053-A → Espejos Linguales (D) Letrales</p>	<p>2106 Endo Feet Aluminum / Regla Endo Aluminio</p> 	<p>Plastico</p>  <p>2107 Amalgum Carrier</p>	<p>Excellent Flexibility</p>  <p>2108 Napkin Holder / Porta Servilletas (Flexible)</p>



1817
 Composite Finishing Polishing Discs
 Assorted Kit 48pcs+strips 75pcs



1818
 Composite Finishing Polishing Discs
 Assorted Kit 40pcs+1pcs Mandrel



1819
 Endo clean Foam
 Autoclavable 134°



Steel Matrice Bands
 Length: 3mtr
 1821-5mm/0.025mm
 1822-5mm/0.04mm
 1823-5mm/0.05mm
 1824-6mm/0.025mm
 1825-6mm/0.04mm
 1826-6mm/0.45mm
 1827-6mm/0.05mm



Striproll
 Length: 15mtr
 1828-9.5mm/0.05mm



Resin Polishing Strips
 Length: 6 mtr
 1829-4mm/fine(Azul/Blue)
 1830-4mm/medium(Rosa/Pink)



1831
 Multi Endu Box
 95 Holes
 (106x132x68mm)
 (Multi Uso, Fresas, Lima, Gutta Parcha...etc)
 Autoclavable 134°



1820
 Endo & Gutta Parcha Ruler
 (Corben Fiber)
 Autoclavable 134°



1838
 Face Mask
 Anti Fog



1836
 Mouth Mirror
 (No.4 Plane Mirror)
 05 pcs Set
 Autoclavable 134°



1837
 Multi Holder Inox
 12 Hole/Agujeros
 (Multi Uso, RA/FG/Punta ultra Sonido)
 Autoclavable 134°



1575
 Bar Holder (inox, Silicon) autoclave 160°
 Fresero (fresas, contra angulo, pieza de mano)



1833
 Wooden Wedge
 Cuña de Maderas
 (Assorted / Surtido)
 100 pcs / Uni



1832
 Wooden Wedge
 Cuña de Maderas
 Extra Fine / Extra Fino
 100 pcs / Uni



1835
 Cassette Instruments
 5 pcs
 (207x83x32mm)
 Autoclavable 134°



1834
 Cassette Instruments
 10 pcs
 (207x139x32mm)
 Autoclavable 134°



212223
Kit of 3 pcs



022 021 023
Mouth opener (Rubber / Goma)
021 (Small /peq)
022 (Medium / med)
023 (Large / grande)
Autoclave: No
Only wash with warm water & Shampo
(Solo limpio con agua caliente y jobon)



Mouth opener (Plastic / Plastico)
019 (Adult / Adulto)
Autoclave: No
Only wash with warm water & Shampo
(Solo limpio con agua caliente y jobon)

A2425
Kit of 3 pcs

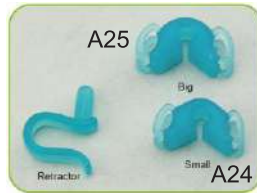

Mouth opener (silicon)
A24 (Small /peq)
A25 (Big / grande)
Autoclavable 134°

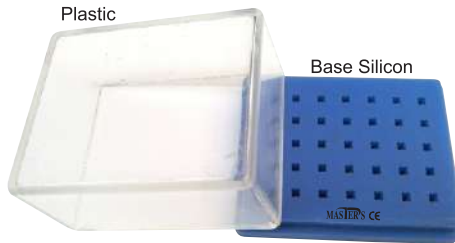

2206
Bur Holder (FG & RA)
Silicon & Plastic
Autoclavable Base Silicon 134°



030
FG / RA Bur Holder (Plastic/Plastico)
Autoclavable 134° (with lid / con tapa)



029
Retractor para Foto Oclusal con diseño innovador. Su mango curvado permite la retracción labial. Autoclavable 134°C
2 pcs / 2 unid (adult / child)



027
Cheek Retractor (Adulto / Niño)
(Plastic / Plastico)
Set of 2pcs / kit de 2 unid
Autoclavable 134°



2201
Study Model (Adult / Adulto)
(Typodonto) 32 Teeth / 32 dientes
without Articulator / Sin articulador



2200
Study Model (Child / Niño)
(Typodonto) 24 Teeth / 24 dientes
with Articulator / Con articulador

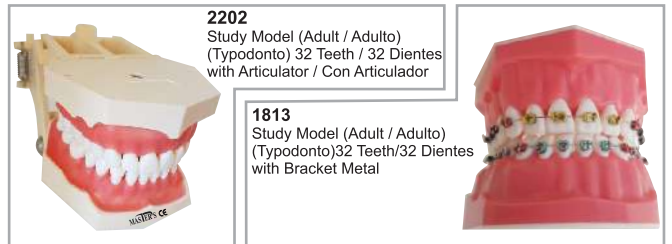

2202
Study Model (Adult / Adulto)
(Typodonto) 32 Teeth / 32 Dientes
with Articulator / Con Articulador

1813
Study Model (Adult / Adulto)
(Typodonto) 32 Teeth / 32 Dientes
with Bracket Metal



1814
Reposicion Dientes con Rices
28 Teeth / 28 Dientes
paking / Embalaje: Plastic box / Caja plastico



2203
Reposicion (Adult / Adulto)
(Typodonto) 32 Teeth / 32 dientes
Packing / Embalaje: Plastic box / Caja plastico

New Products / Producto Nuevo

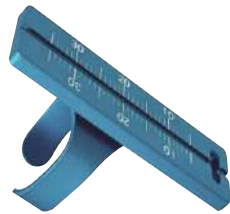

054
 Endo File Ring (Aluminum)
 Anillo Para lima Endo (Aluminio)
 Autoclave 134°C

053
 Matrices Box (Inox)
 100 Pcs (Medium Hard)
 Caja Matrices (Inox)
 100 Unid (Duro Mediano)



052
 Dispensing Impression Gun
 1:1/1:2(50ml)

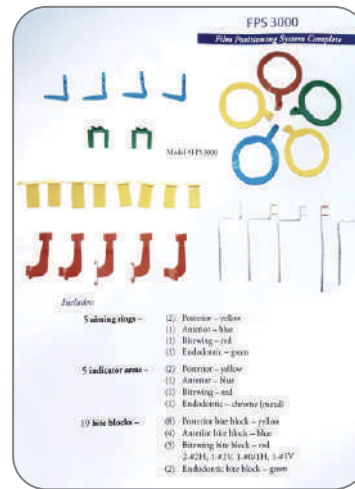

051
 Film positioning System Complete
 Sistema posicionador de radiografía completo



048-B
 Dental Lab Korea Electric Motor Max 35000rpm Handpiece
 Speed:0~35,000RPM Electric Handpiece; Fit with 2.35mm Burs/Bits
 Strong 90 Metal Control Box
 Less-vibration standard carbon brush motor
 On/Off Foot Pedal Switch



049
 Dental Lab Handpiece & Control Box
 STRAIGHT & CONTRA-ANGLE
 Korea Strong Series Handpiece
 0~35,000 RPM Handpiece
 CE Certification



KEY RINGS / LLAVEROS

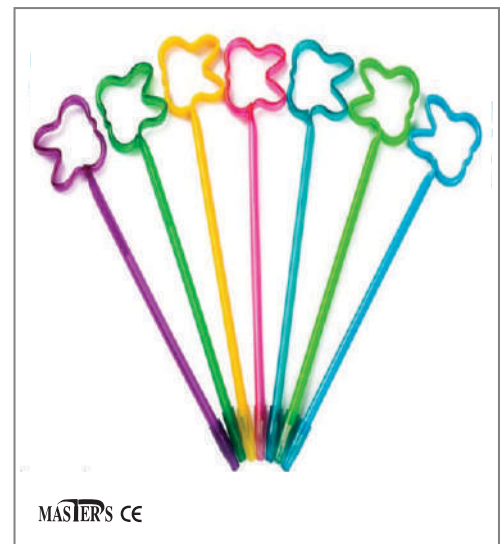

KR-12

Tooth Shape Ball Pen (Available 25 Pcs Bag)
Bolígrafo con forma de diente (Disponible Bolsa de 25 unid)

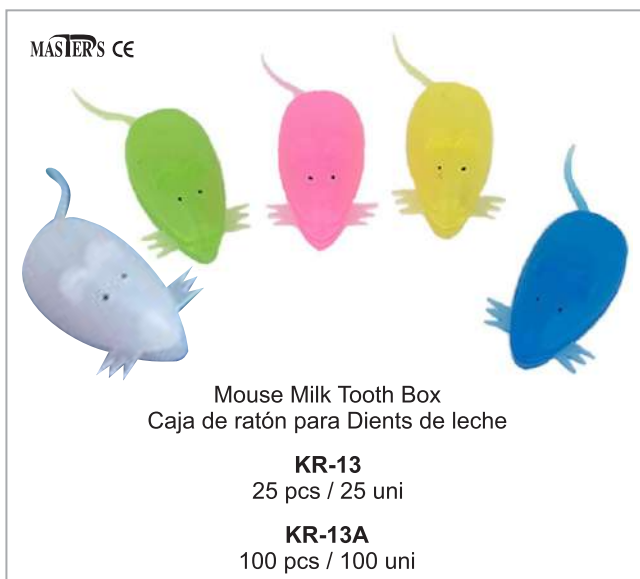

Mouse Milk Tooth Box
Caja de ratón para Dients de leche

KR-13
25 pcs / 25 uni

KR-13A
100 pcs / 100 uni



KR-14

Milk Tooth Box (Available 50 Pcs Bag)
Caja Para dientes de leche
(Disponible Bolsa de 50 unid)



New Products / Nuevo Productos



1815
Cotton Holder (Sucio)
inox



1151
Cotton Holder (Limpio)
inox



1816
Endodontic Box (inox)



1145
Endodontic Box (inox)



1429A
Mixing Bowl Inox
60 mm



1429
Mixing Bowl Inox
30 mm



055
Burr Wash Holder inox



1154
Spirit Lamp (inox)



2116
Identification Rings
Aros Para Identificador
Colour Available / Color Disponible
Yellow, Red, Green, Blue, White.
Amarillo, Rojo, Verde, Azul, Blanco.
(Autoclavable)
Pack 50 Pcs / 50 Unid

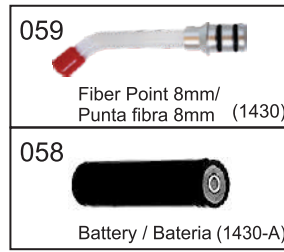

059
Fiber Point 8mm/
Punta fibra 8mm (1430)



058
Battery / Bateria (1430-A)

1430
Led Curing Light

- Feature:
1. High articulation optical fiber (08 mm)
 2. Three working modes: strong, gradually strong, flashing
 3. Optional working time: 05s, 10s, 20s, 30s, 40s
 4. Light intensity: 1500mw/cm²
 5. Automatic inactive, automatic power off.

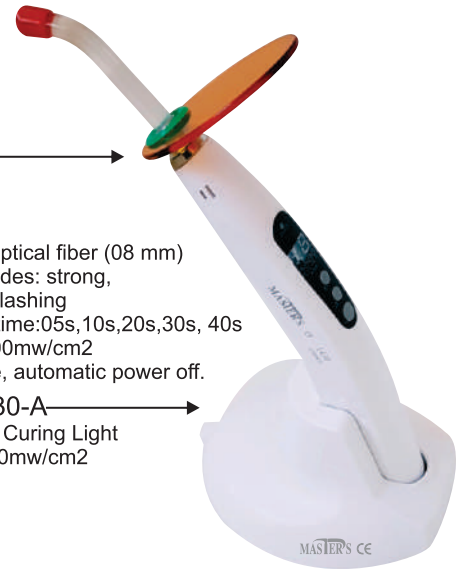

1430-A
Led Curing Light
1800mw/cm²

1430-B
Led Curing Light (Colour)

- Feature:
1. High articulation optical fiber (07 mm)
 2. Three working modes: strong, gradually strong, flashing
 3. Optional working time: 15s, 20s, 25s
 4. Light intensity: 1500mw/cm²
 5. Automatic inactive, automatic power off.

Colour Available:
Silver, Purple, Orange, Green,
Black, Golden.

Colores Disponible:
Gris, Morado, Naraja, Verde,
Negro, Oro.

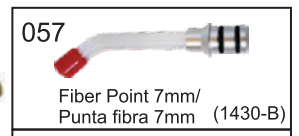

057
Fiber Point 7mm/
Punta fibra 7mm (1430-B)

056
Battery / Bateria (1430-B)

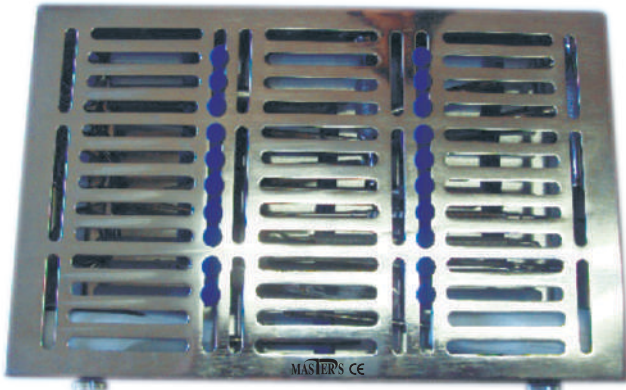

1576
29x18.5x3.50cm
Sterilize Trays Large INOX

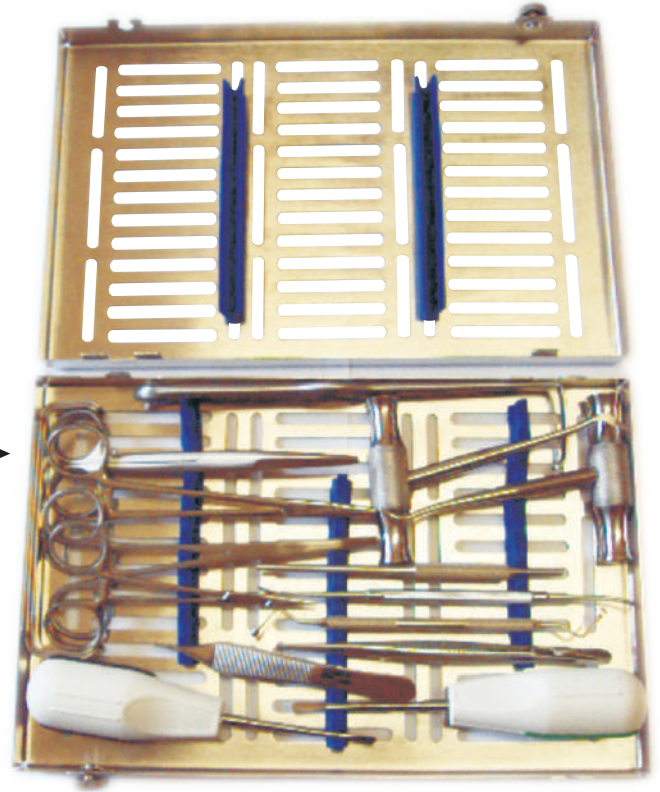

1666
5 Pcs
Sterilize Trays INOX

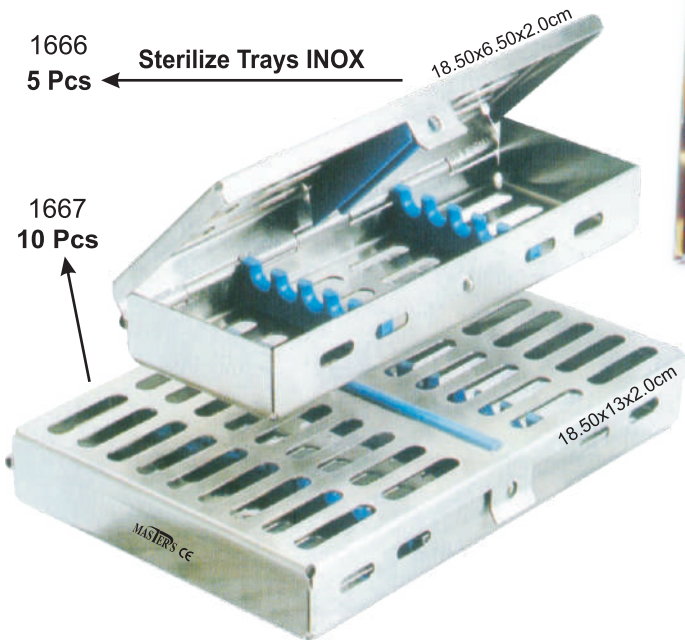

1667
10 Pcs



1666-B
Sterilize Trays INOX
7-Pcs



014-B
Instruments Tray 20pcs (Inox)
27.5x19.5x3.5cm



015-B
Instruments Tray 10pcs (Inox)
20x14.5x3.5cm



016-B
Instruments Tray 07pcs
20x10.5x3.5cm
(Inox)



017-B
Instruments Tray 05pcs
20x8x3.5cm
(Inox)



Ultrasonic Scaling Scalar / Punta ultrasonido



Scaling (Used for SIRONA)

GS1			
	Supragingival scaling		
GS2			
	Supragingival scaling		
GS3			
	Supragingival scaling		
GS4			
	Supragingival scaling		



compatible with SATELEC scaler



HD-7L
Handle with LED / Mango con luz



compatible with woodpecker and EMS scaler



HW-3H
Handle without LED / Mango sin luz



compatible with SATELEC scaler



HD-7H
Handle without LED / Mango sin luz



Available only blister of 5 pcs/
Solo disponible bolister de 5 unid



Torque Wrench / Liave

041	EMS
042	SATELEC
043	SIRONA



Stainless Steel / Nickel Titanium Instruments



Stainless Steel / NITI Spreaders

- Smooth conical shape with pointed tip. Used for measuring the space between gutta percha or other filling materials, so as to increase the density of canal fillings.
- Taper: .02
- Packing: 6 pcs/box

SIZE / PACKING	
x6	x1 ISO 015-040
015 020 025 030 035	015 020 025 030 035 040
040	

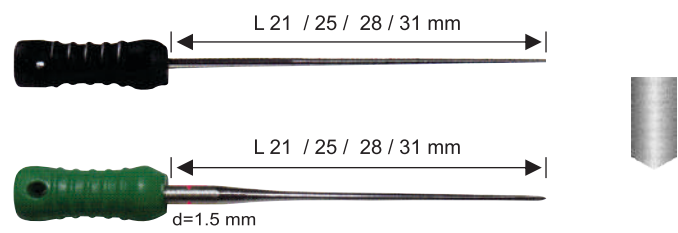

Peeso Reamers (Engine)

- Material: Imported high quality raw materials, high corrosion resistance, by the refining production, has the equilibrium and stability of hardness.
- Head: Circular cutting edge is good to prevent the steps and impalement.
- Special process: specially designed, if broken, broken parts is closed to handle, which is easy to remove from the root canal.
- Handle: each has a ring logo to distinguish, used for preparation of upper 1/3 root canal crown; to bring out the filled material in the root canal; to prepare the post path.
- Recommended Rotary Speed : 800~1200 rpm
- 6 pcs/box (single size & assortment)

SIZE / PACKING	
x6	x1 ISO 1-6
N°1 Ø0.50mm, N°2 Ø0.70mm, N°3 Ø0.90mm, N°4 Ø1.10mm, N°5 Ø1.30mm, N°6 Ø1.50mm,	N°1 N°2 N°3 N°4 N°5 N°6

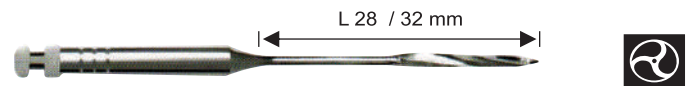

Gates Drills (Engine)

- Material: Imported high quality raw materials, high corrosion resistance, by the refining production, has the equilibrium and stability of hardness.
- Head: Circular cutting edge is good to prevent the steps and impalement.
- Special process: specially designed, if broken, broken parts is closed to handle, which is easy to remove from the root canal.
- Handle: each has a ring logo to distinguish, to be applied in pulp canal protective, to establish the access to root canal's entrance; to enlarge the opening of the teeth root canal's crown part; to prepare the upper 2/3 part of molar root canal crown.
- Recommended Rotary Speed : 800~1200 rpm
- 6 pcs/box (single size & assortment)

SIZE / PACKING	
x6	x1 ISO 1-6
N°1 Ø0.70mm, N°2 Ø0.90mm, N°3 Ø1.10mm, N°4 Ø1.30mm, N°5 Ø1.50mm, N°6 Ø1.70mm,	N°1 N°2 N°3 N°4 N°5 N°6

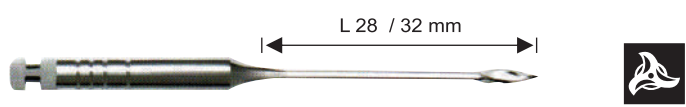



鎢鋼車針

Tungsten carbide bur

鎢鋼車針 Tungsten carbide bur



Fig.31
柱形裂钻十字刃

US NO.	556	556L	557	558	559	560	562	563L
HP(44.5mm)	008	009	010	012	014	016	021	023
FG(19mm)			010	012				
RA(22.5mm)								

O8正牌车针 12刃
适用于去除充填粘
结剂及抛光

GIG NO.	H379-023ALGK	H22-016ALGK	7664 375R
DIAMETER(1/10mm)	023	016	014



Fig.33
锥形裂钻十字刃

US NO.	698	699	700	701	702	703	704	699L	700L	701L
HP(44.5mm)	008	009	010	012	016	021	023	009	010	012
FG(19mm)	008	009	010	012	016				010	012
RA(22.5mm)										



Gig.31R
圆头裂钻 十字刃

US NO.	1557	1558
FG(19mm)	010	012
RA(22.5mm)		



Fig.2
球钻

US NO.	33½	34	35	36	37	38	39	40	41
HP(44.5mm)	006	008	010	012	014	016	018	021	023
FG(19mm)	006	008	010	012	014	016			
RA(22.5mm)									



Gig.21R
圆头裂钻 斜刃

US NO.	1157	1158
FG(19mm)	010	012
RA(22.5mm)		



Fig.1
球钻

US NO.	¼	½	1	2	3	4	5	6	7	8
HP(44.5mm)	005	006	008	010	012	014	016	018	021	023
FG(19mm)	005	006	008	010	012	014	016	018		
RA(22.5mm)										



Gig.23
锥形裂钻 斜刃

US NO.	169L	170	171
FG(19mm)	009	010	012



perfect®

金鋼砂車針

特點:

- ◆ 采用天然金鋼石粉
- ◆ 采用先進的金鋼砂處理技術
- ◆ 具有超強磨削能力

Diamond Burs

Feature:

- ◆ Made of natural diamond powder
- ◆ Advanced engineered diamond technology
- ◆ With maximum cutting efficiency



5支/板 5pos/blister

金鋼砂車針 Diamond Burs



S R E T S A M



NEODENTAL
INSTRUMENTOS DENTALES

639 942774
neodentallevante@gmail.com

金剛砂車針 Diamond Burs

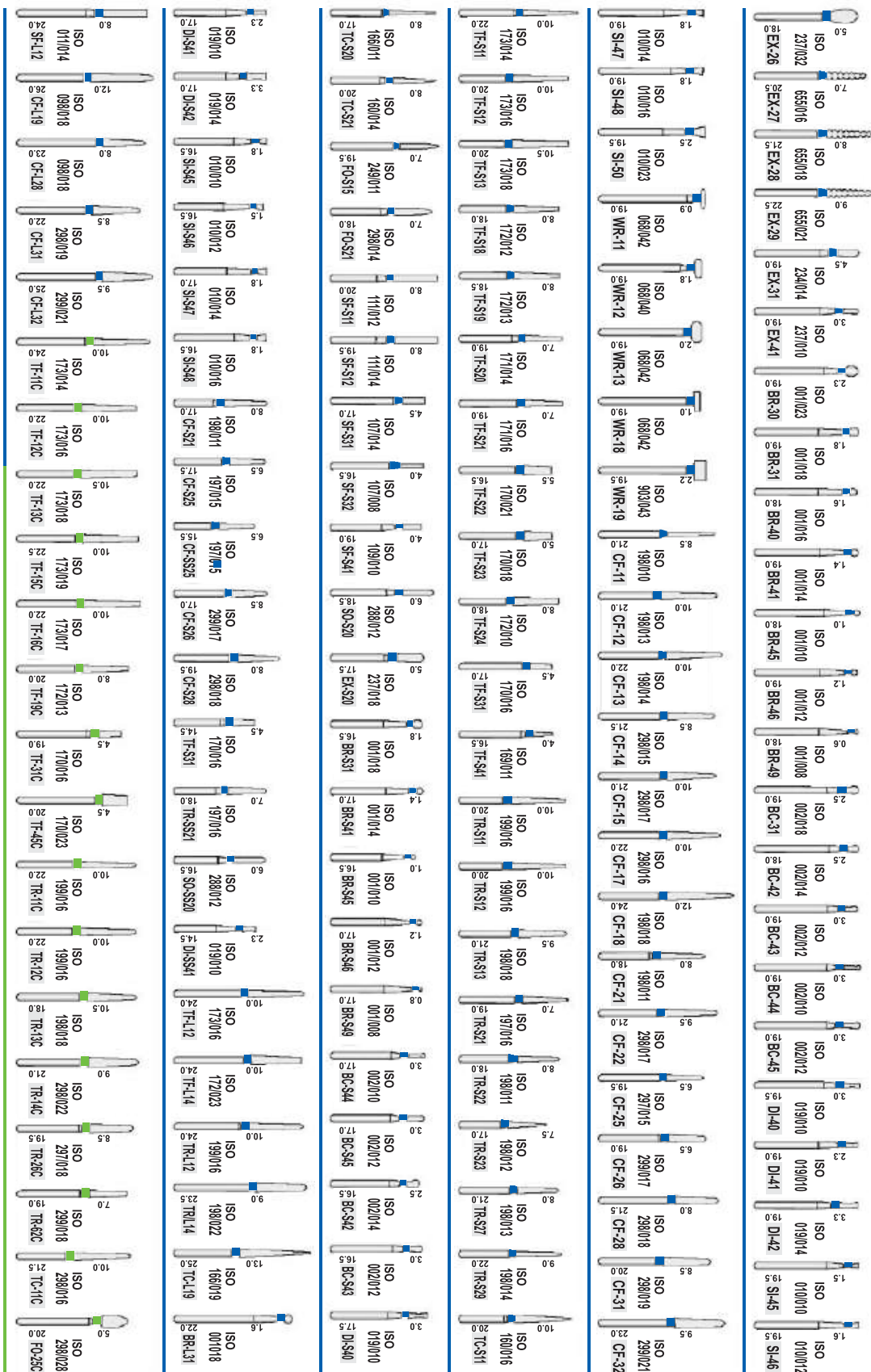

S E T S A M



NEODENTAL
INSTRUMENTOS DENTALES

639 942774
neodentallevante@gmail.com



金鋼砂車針 Diamond Burs

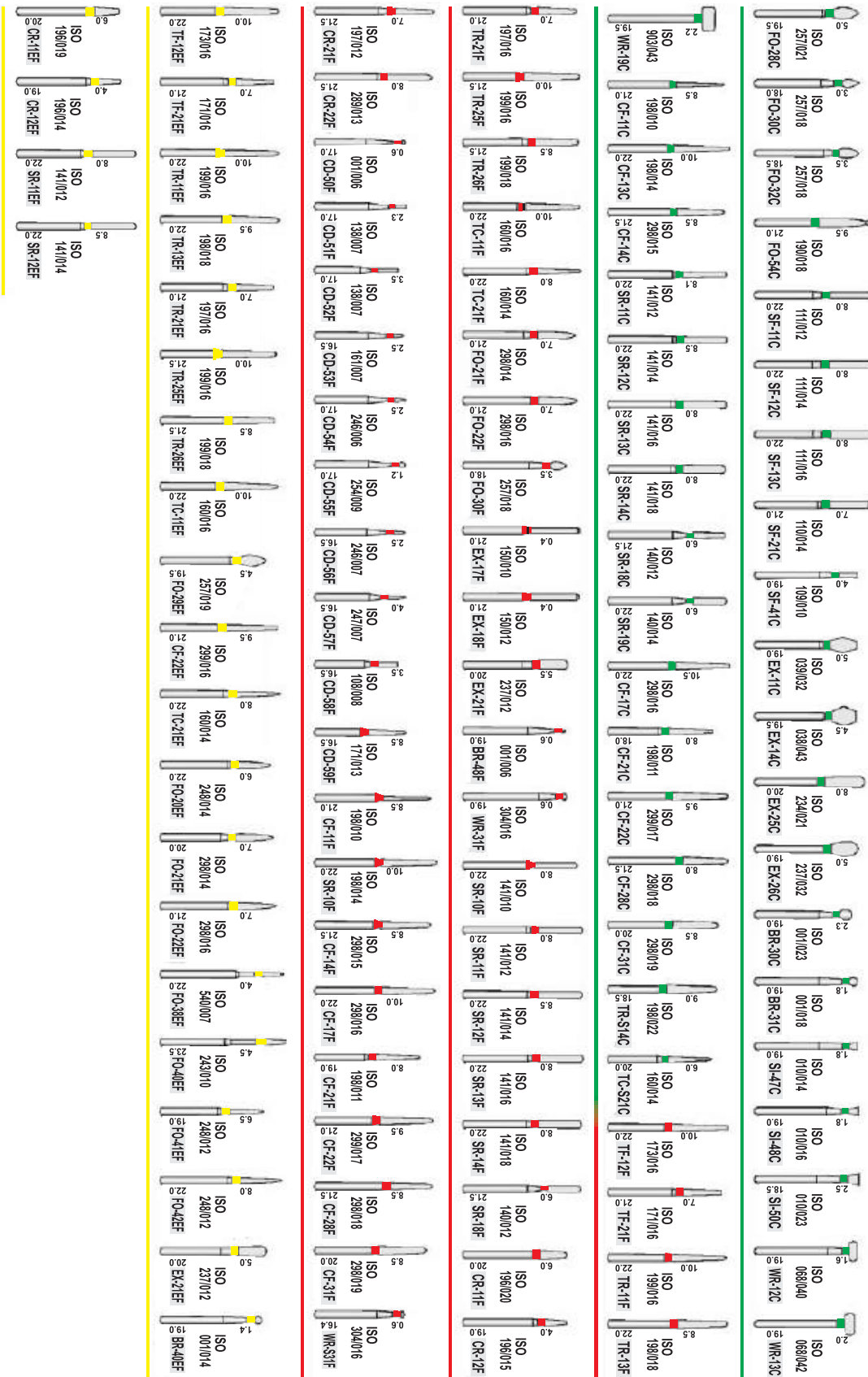

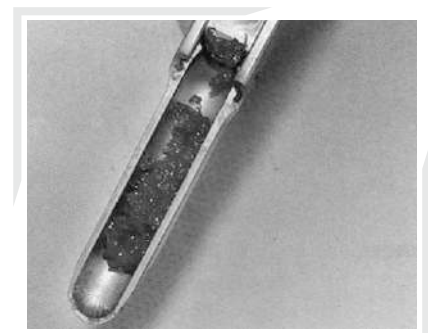
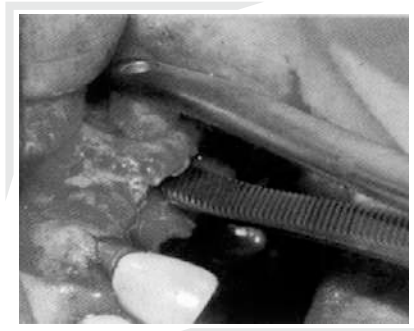

Dental Implant Instruments Catalogue



Implant Instruments

PERIOTOMOS



1600

PERIOTOMOS



1601

PERIOTOMOS



1602

PERIOTOMOS



1603

PERIOSTOTOMOS



1604



Implant Instruments

PERIOSTOTOMOS

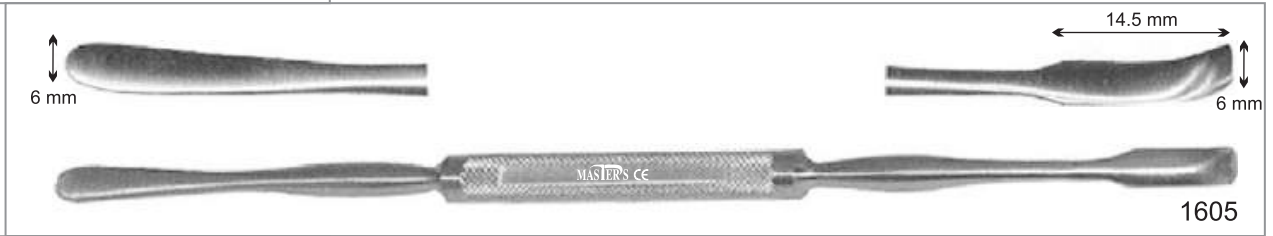

PERIOSTOTOMOS



DESPEGADOR PERIOSTICO



CURETAS OSEAS CUCHARILAS DE LEGRADO



CURETAS OSEAS CUCHARILAS DE LEGRADO



CURETAS OSEAS CUCHARILAS DE LEGRADO





Implant Instruments

PINZA DE CAMPO

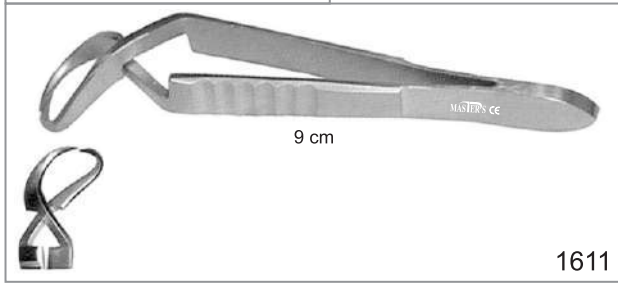

PINZA MOSQUITO



TWZ BROWN

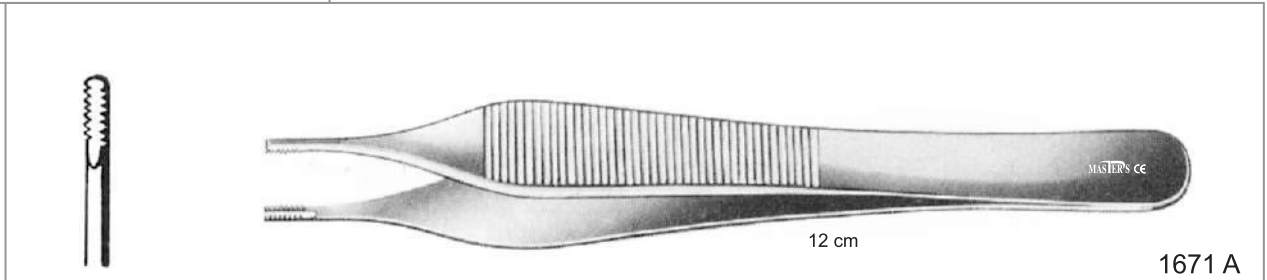

PINZA ADSON

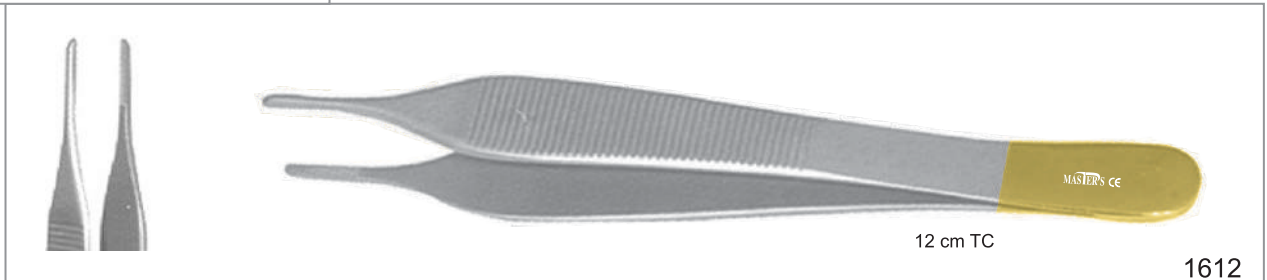

PINZA DE DISCCION BAKEY

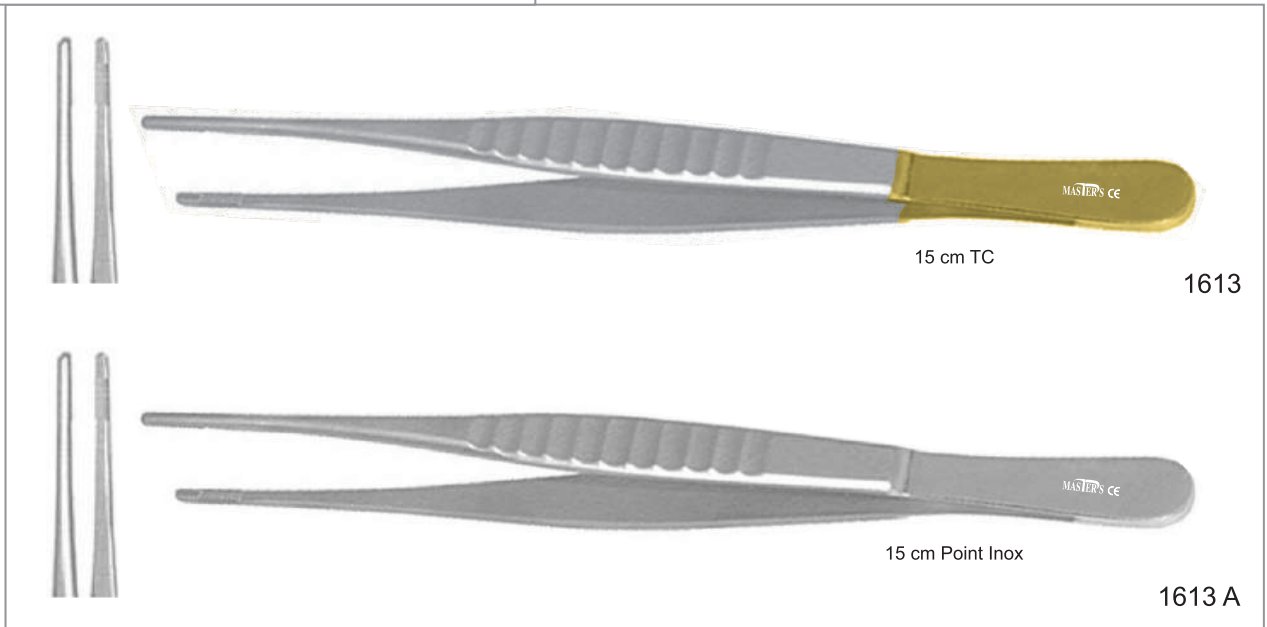



Implant Instruments

COMPÁS QUÍRURGICO

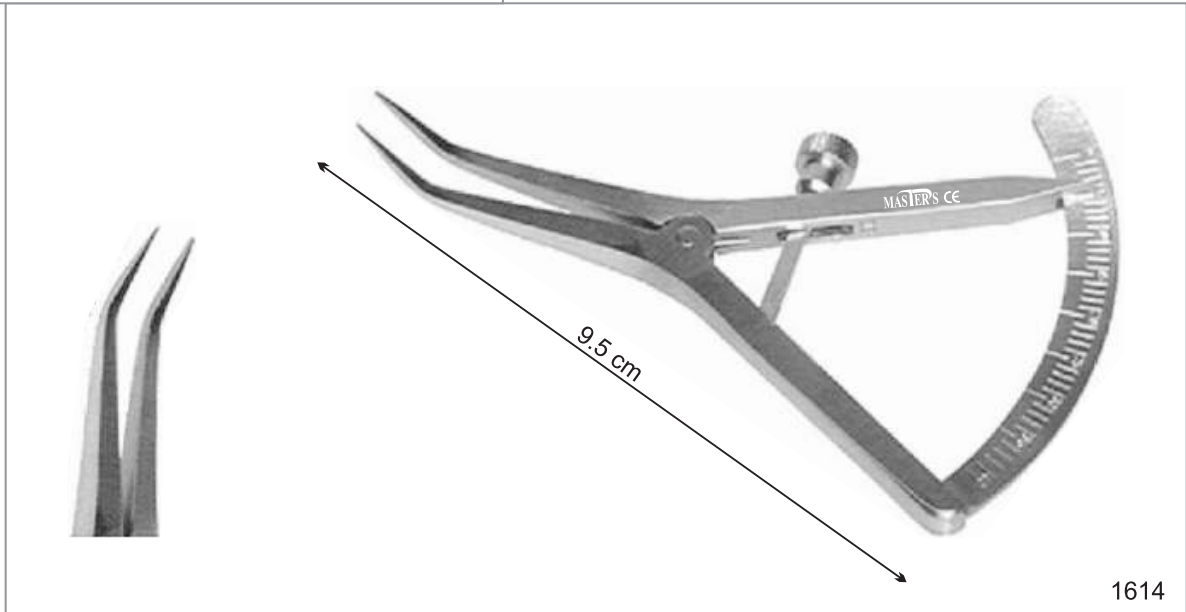

REGLA QUIRÚRGICA

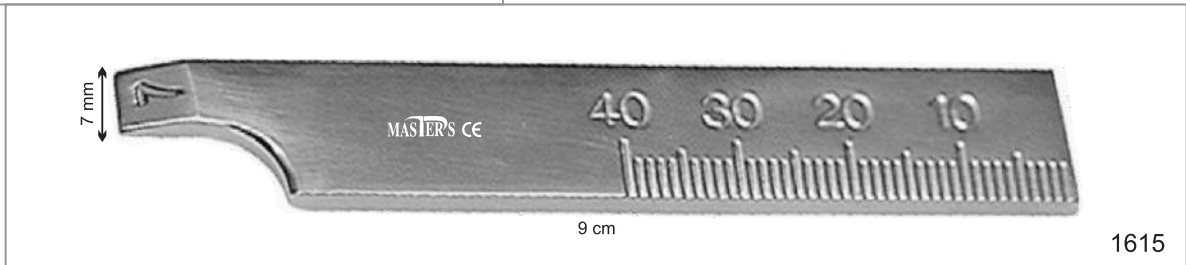

TIJERA PARA MICROCIURUGÍAS

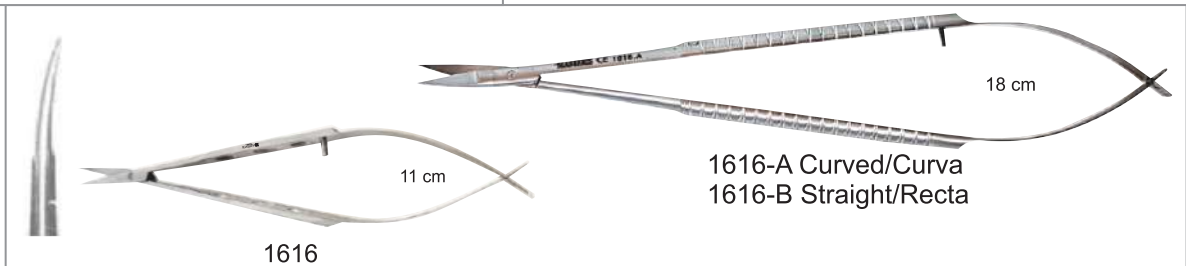

TIJERA PARA MICROCIURUGÍAS

CURVA

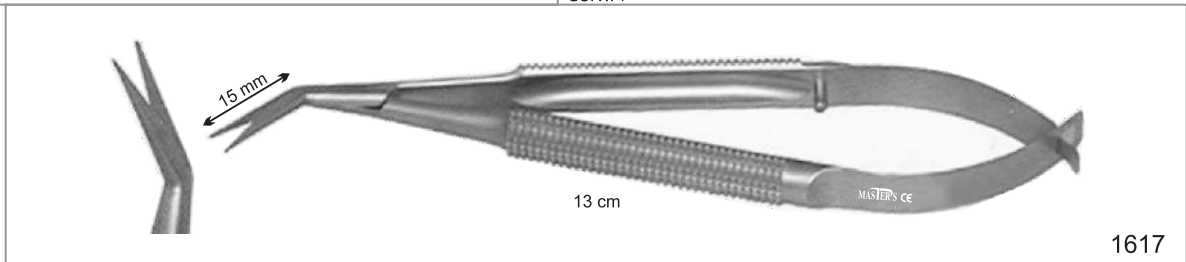



Implant Instruments

TIJERA DE TEJIDOS

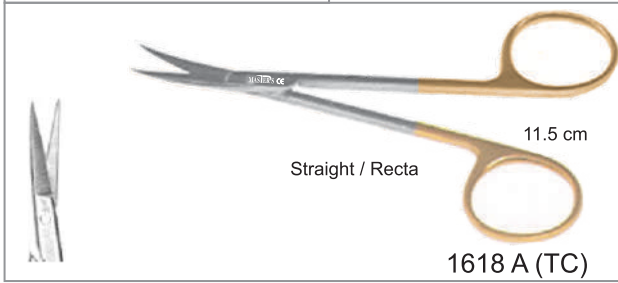

TIJERA DE TEJIDOS

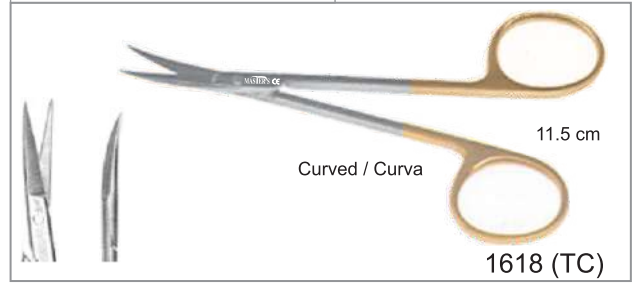

GUBIAS

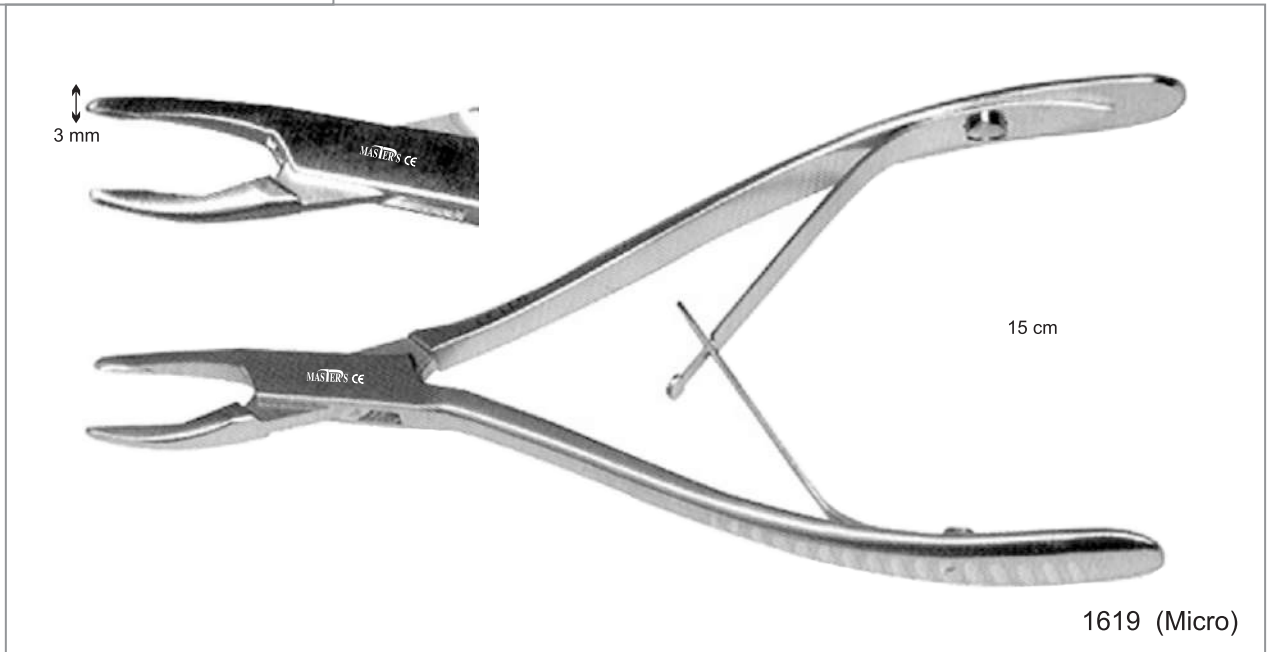

GUBIAS





Implant Instruments

PORTA-AGUJAS CASTROVIEJO

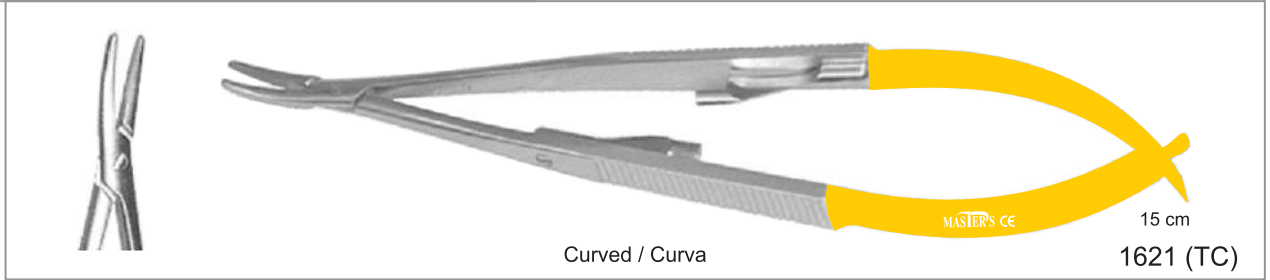

CURETA MOLT



MARTILLO



MOLINILLO DE HUESO

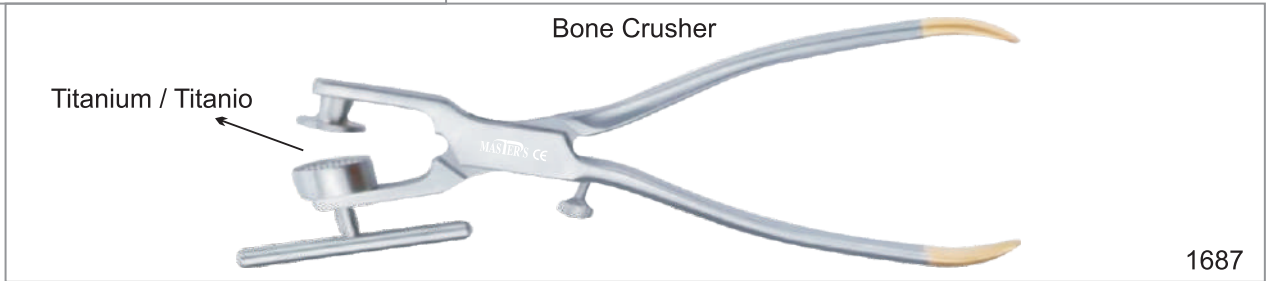



Implant Instruments

MANGO DE BISTURI

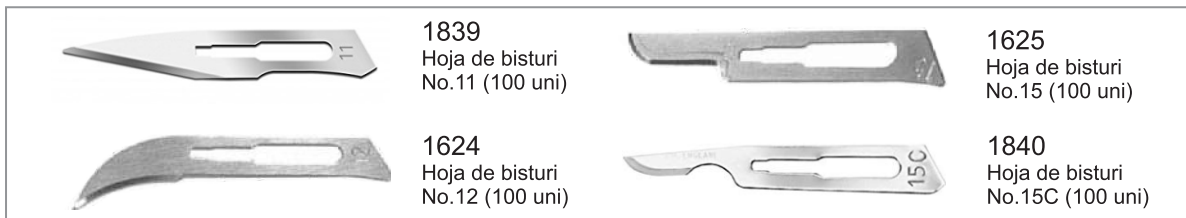
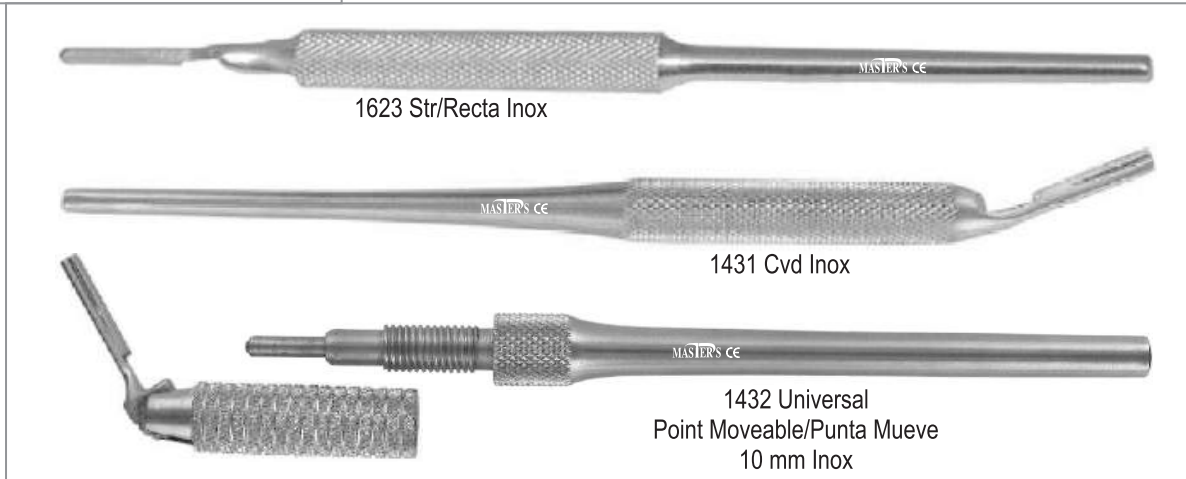

MANGO Y MICROESPEJO

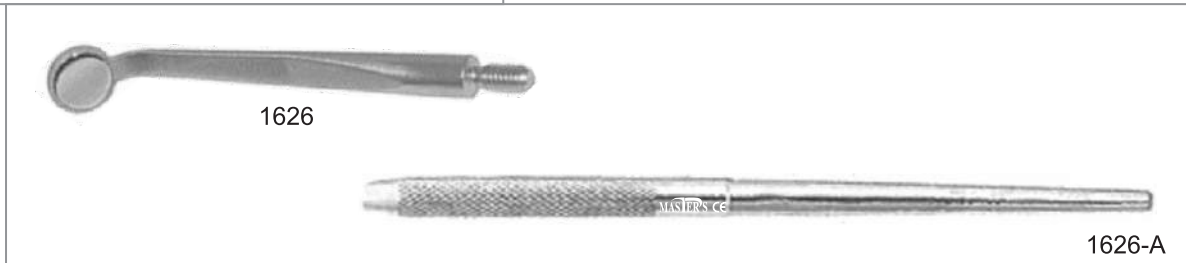

ESPESIMETRO PARA HUESO

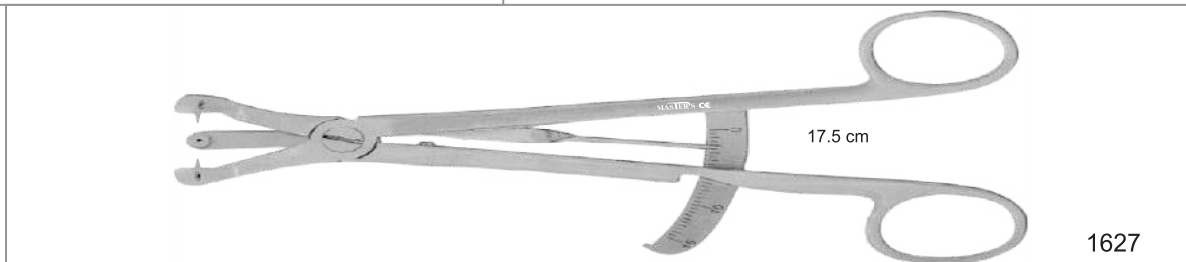

INYECTOR DE HUESO

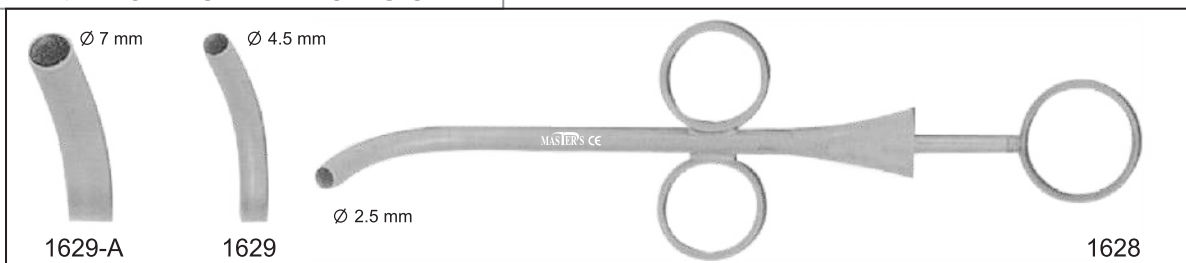



Implant Instruments

SEPARADOR FARABEU

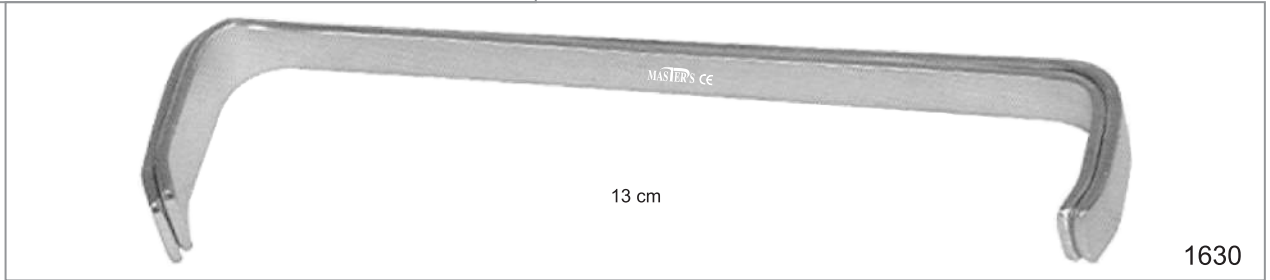

SEPARADOR DE TEJIDOS



KIT DE ELEVACION DE SENO



RASPADOR DE HUESO



RASPADOR DE HUESO

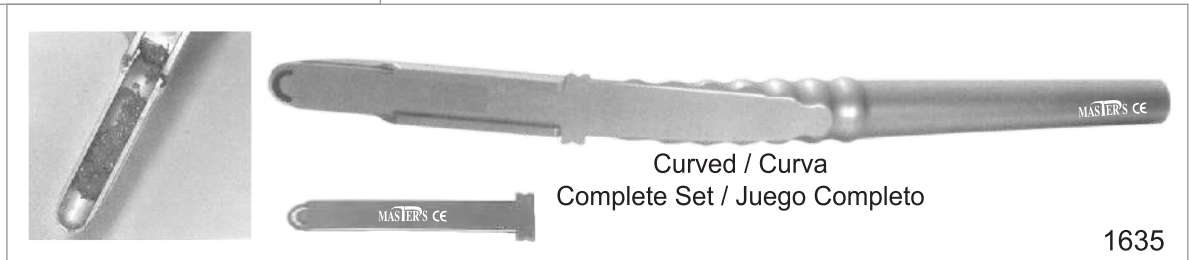



Implant Instruments

PINZA PARA MICROCIRUGIA

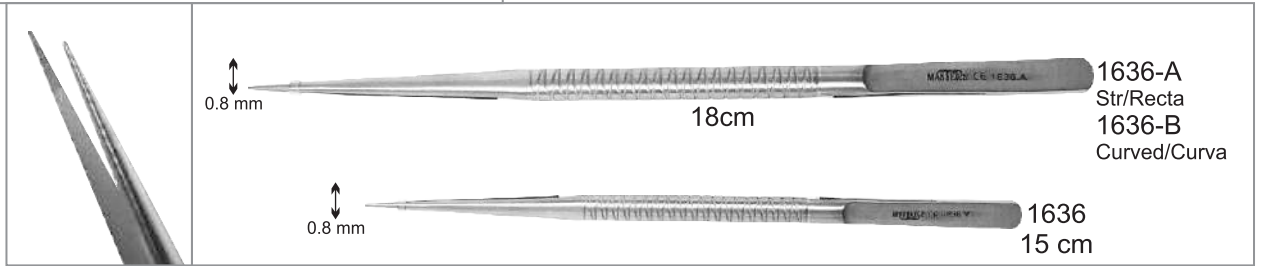

PORTA-AGUJAS PARA MICROCIRUGIA

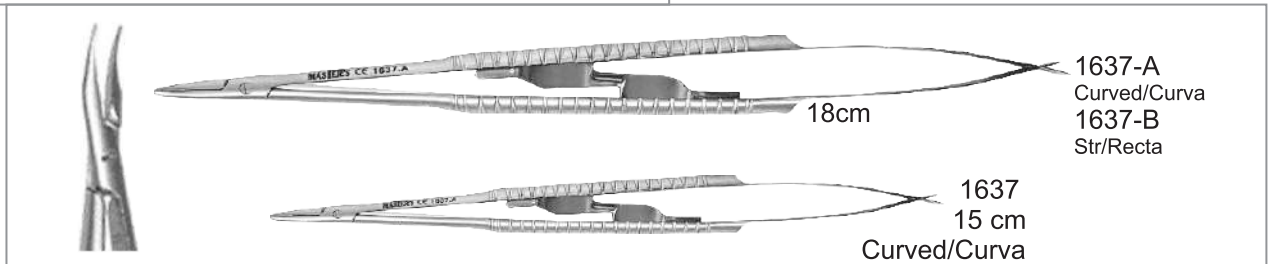

KIT PARA MICROCIRUGIA

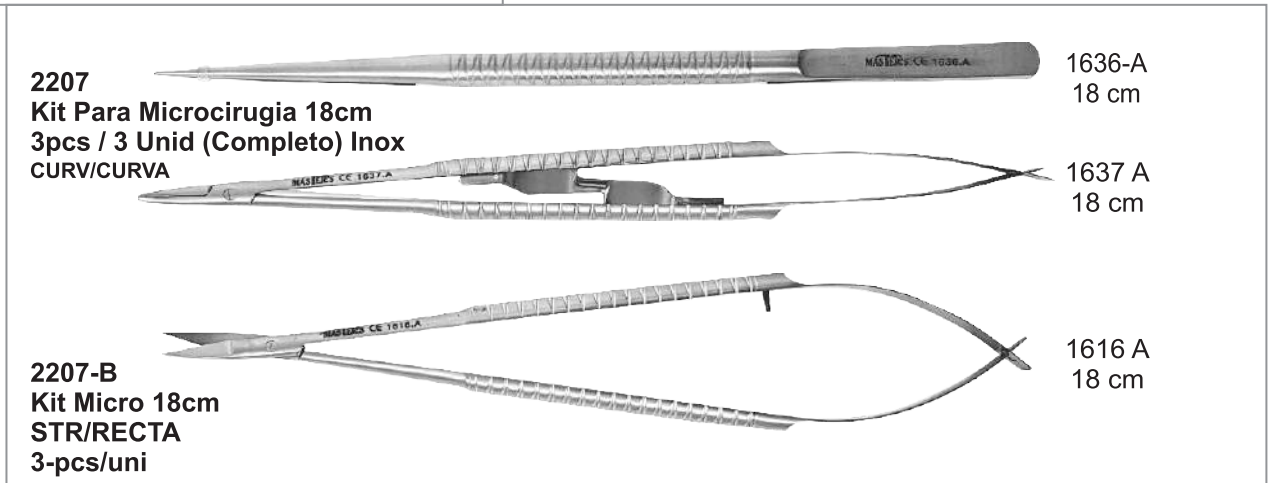

COMPACTADORES DE HUESO

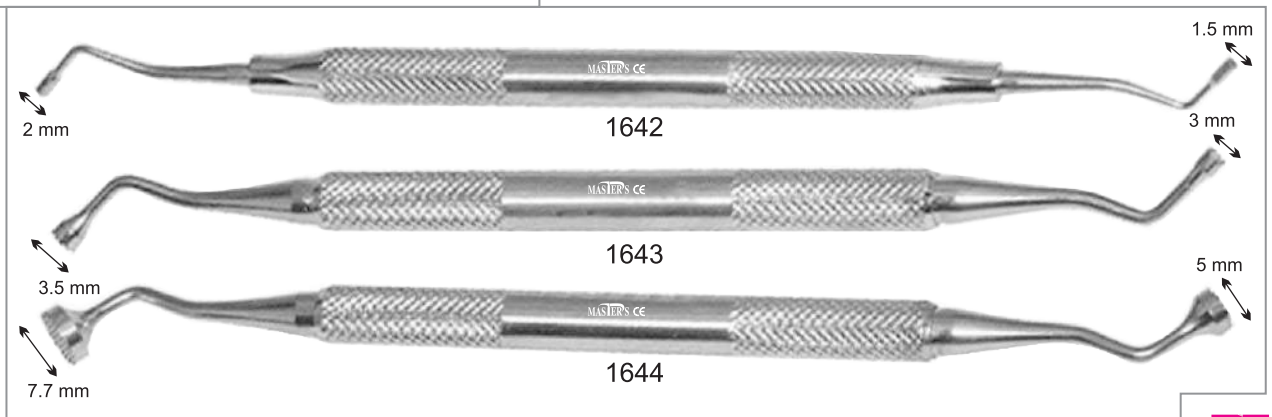



Implant Instruments

KIT DE ELEVACION DE SENO

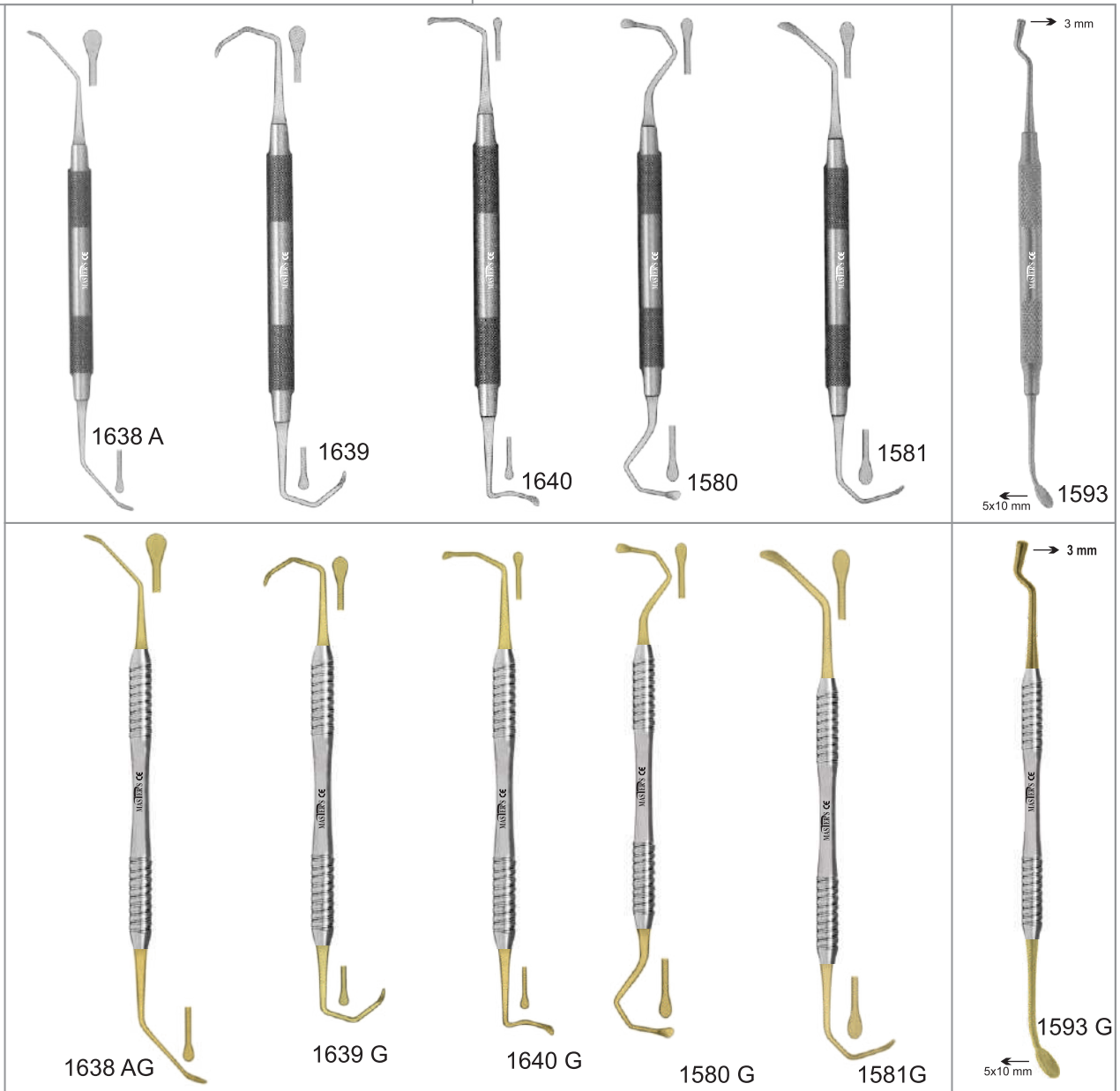

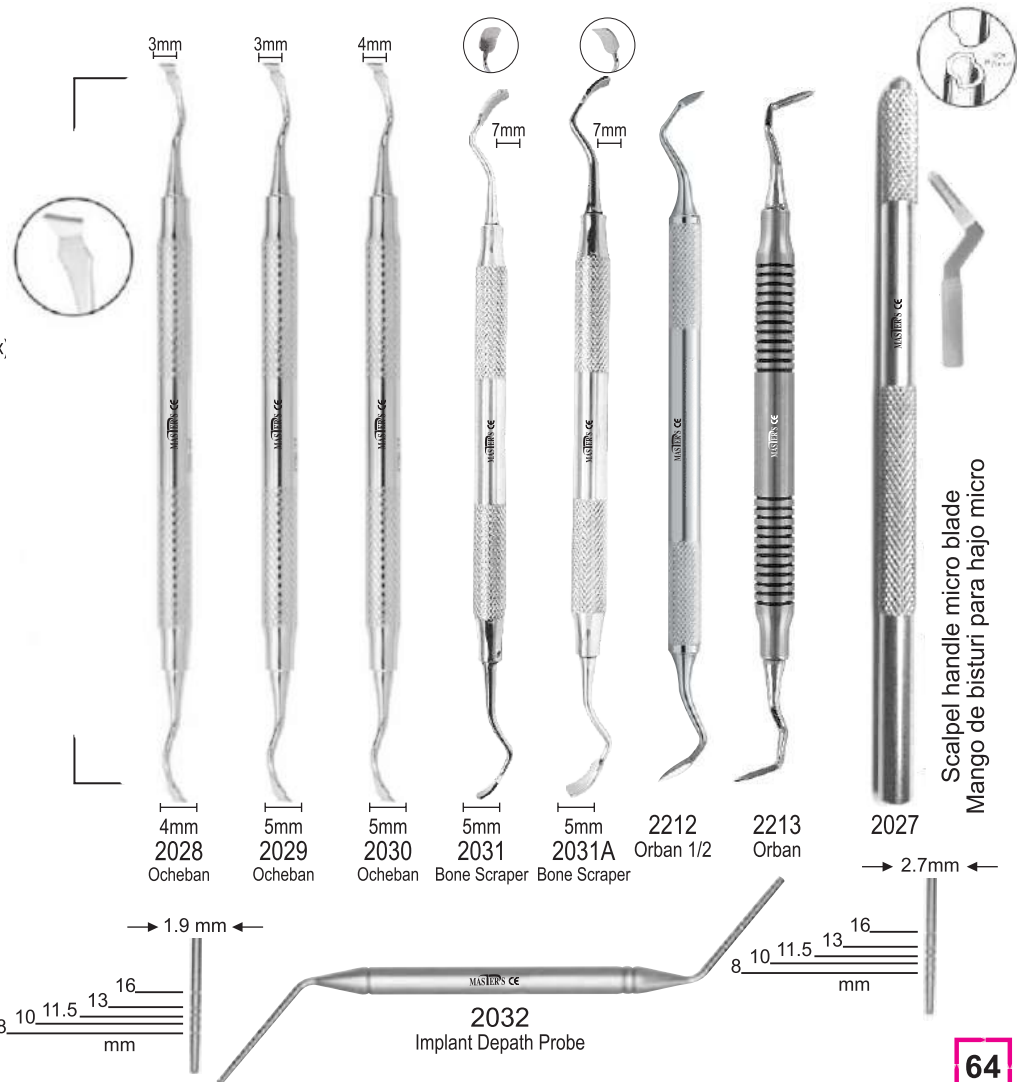
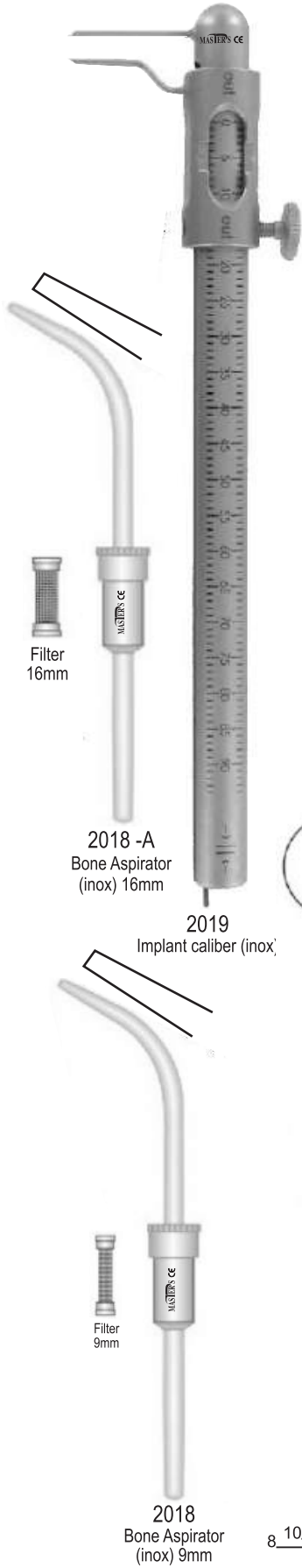



Implant Instruments

CINCELES

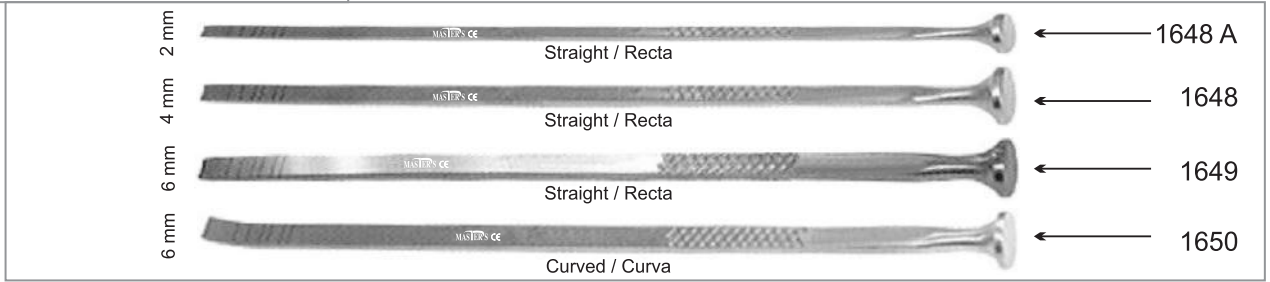

KIT DE OBTENCION DE INJERTO DE TIBIA O CADERA

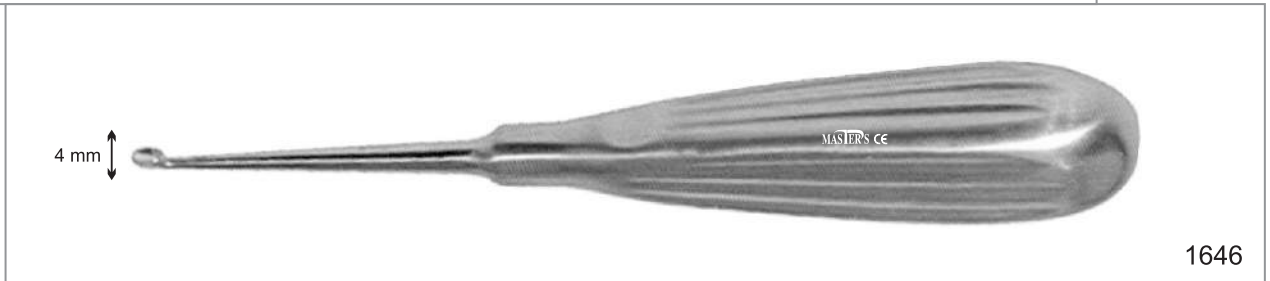

KIT DE OBTENCION DE INJERTO DE TIBIA O CADERA

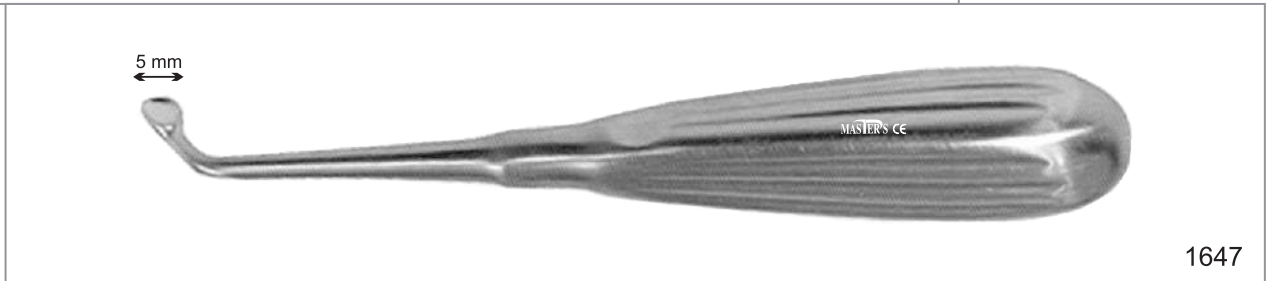

PINZA PARA MEMBRANAS

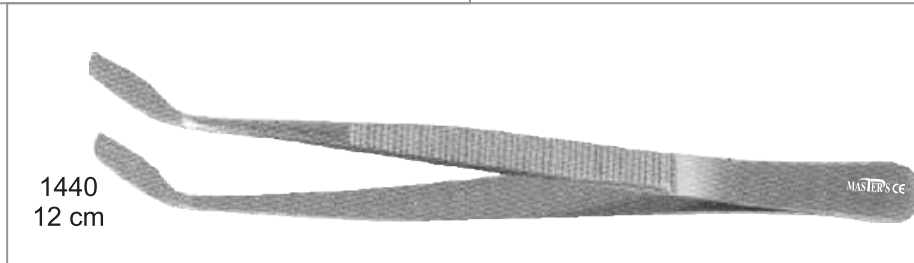

CURETA TEFLON



Implant Instruments



IMPLANT TWEEZER



15 cm

1582

PINZA PARA INJERTOS EN BLOQUE

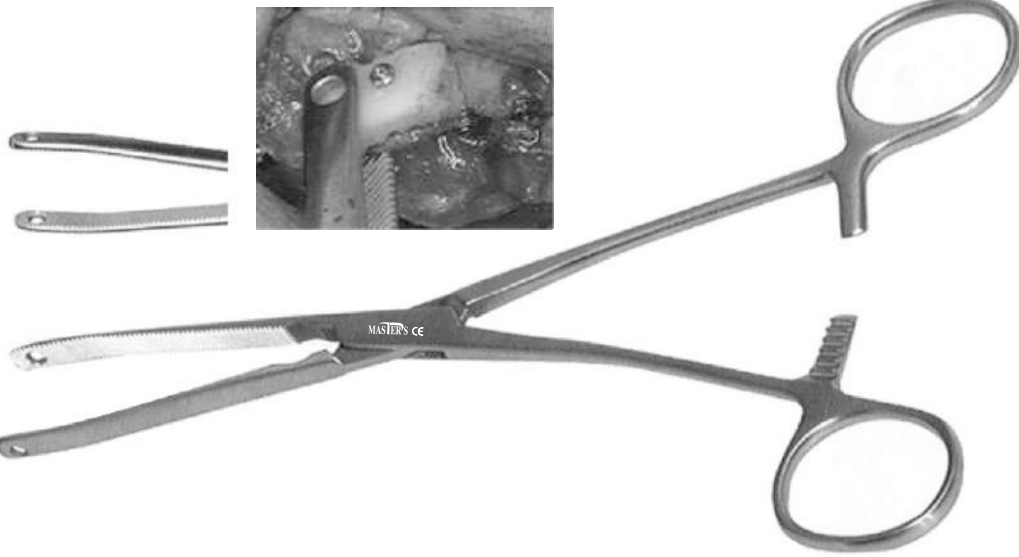

1651

PINZA PARA INJERTOS EN BLOQUE

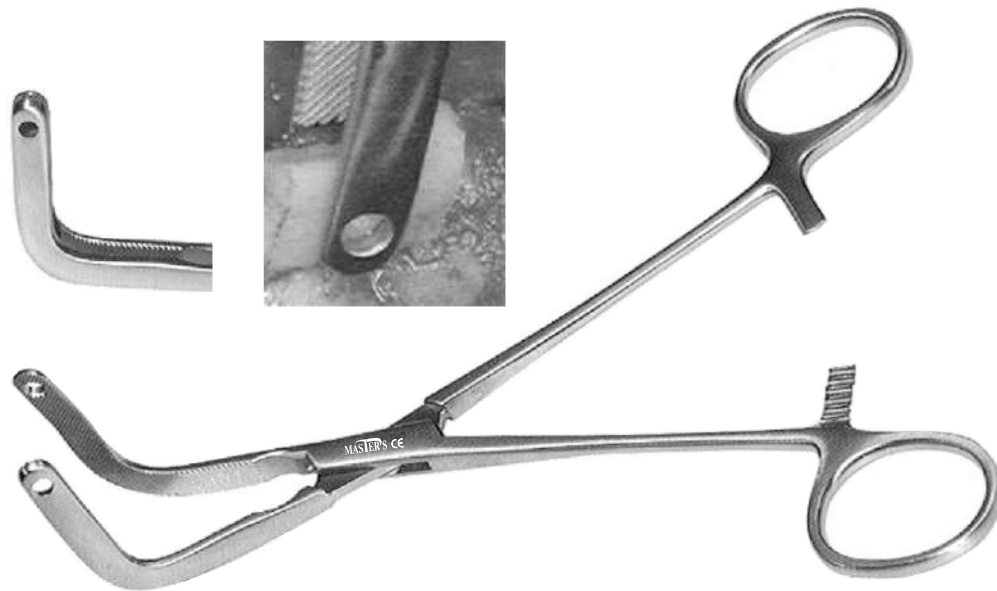

1652



Implant Instruments

OSTEOTOMOS DILTABORES Y ESPANSORES

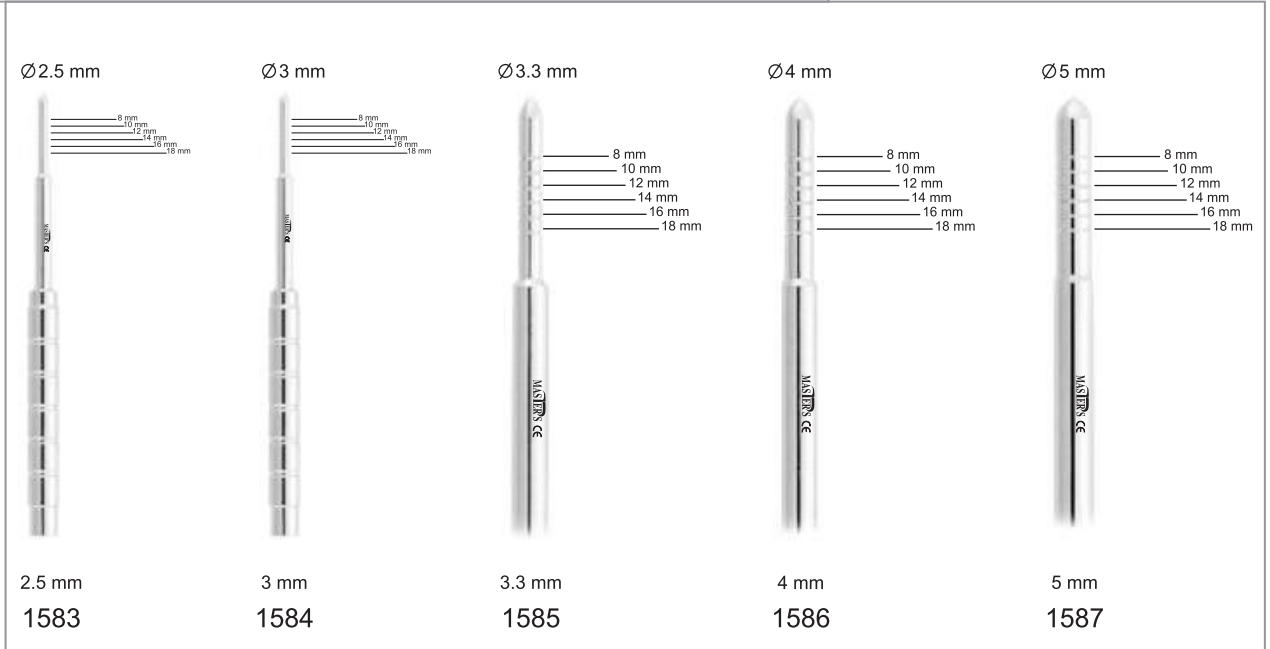

OSTEOTOMOS DILTABORES Y ESPANSORES

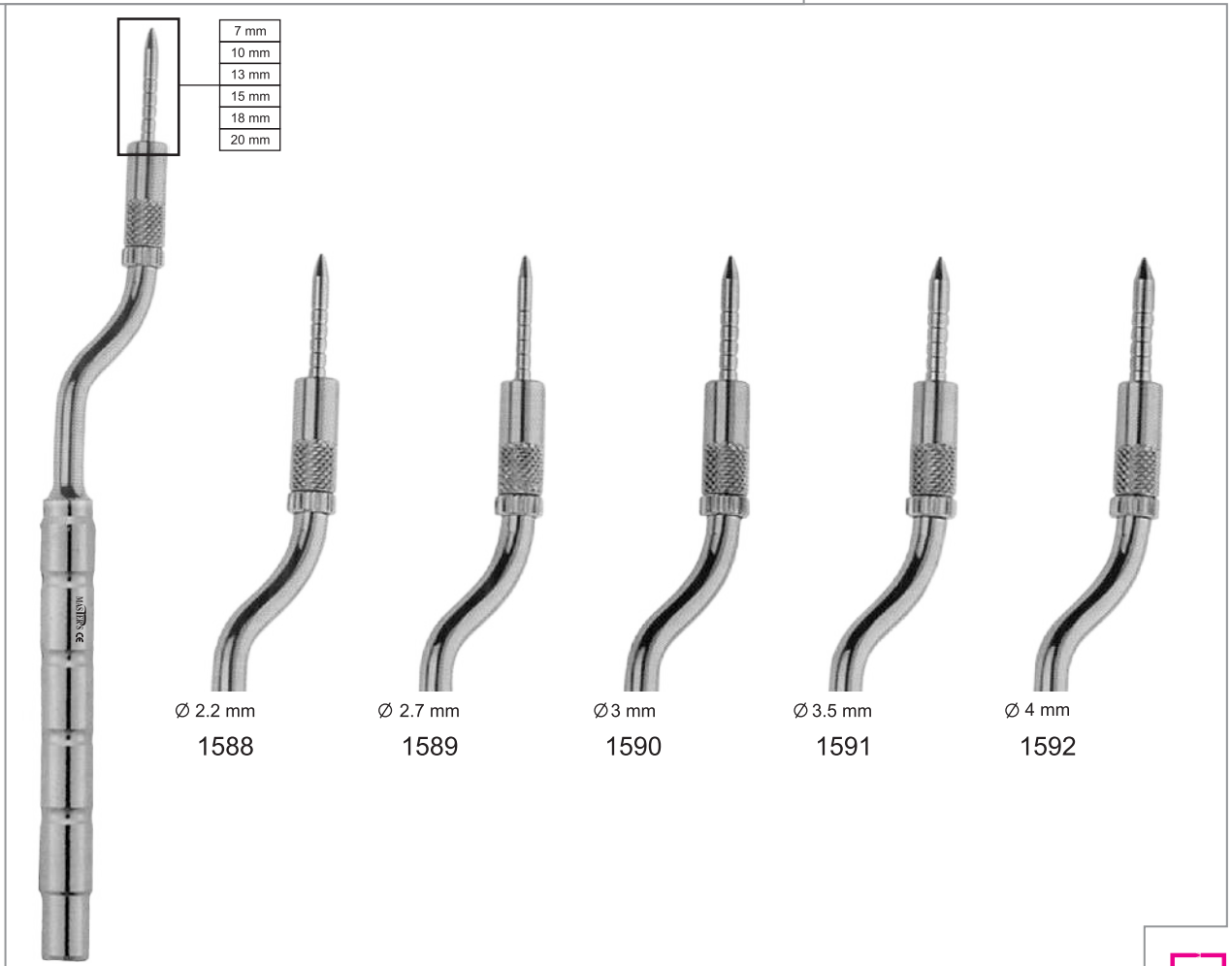



Implant Instruments

CONTENIDO

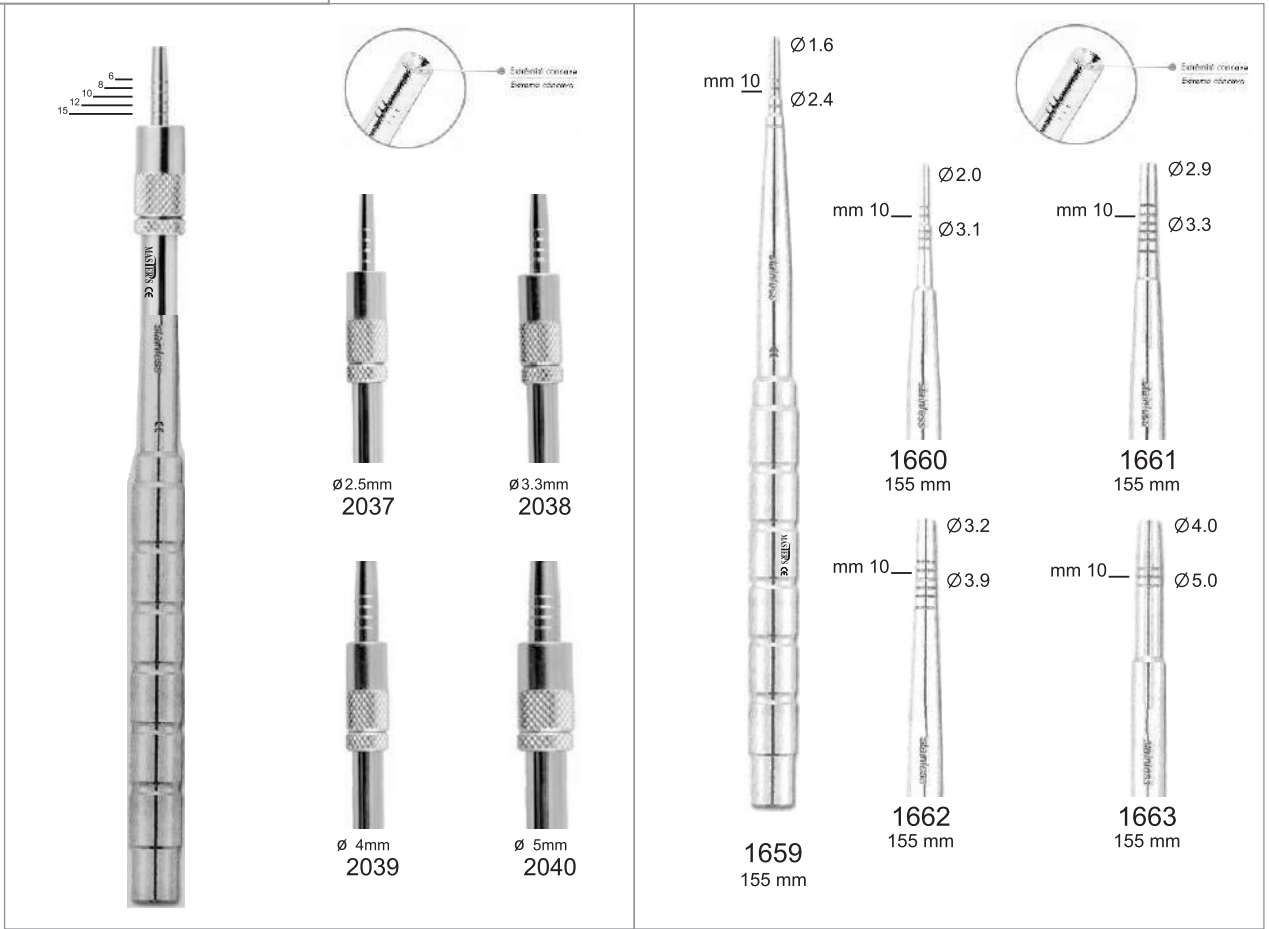

CONTENIDO/OSTEOTOMOS

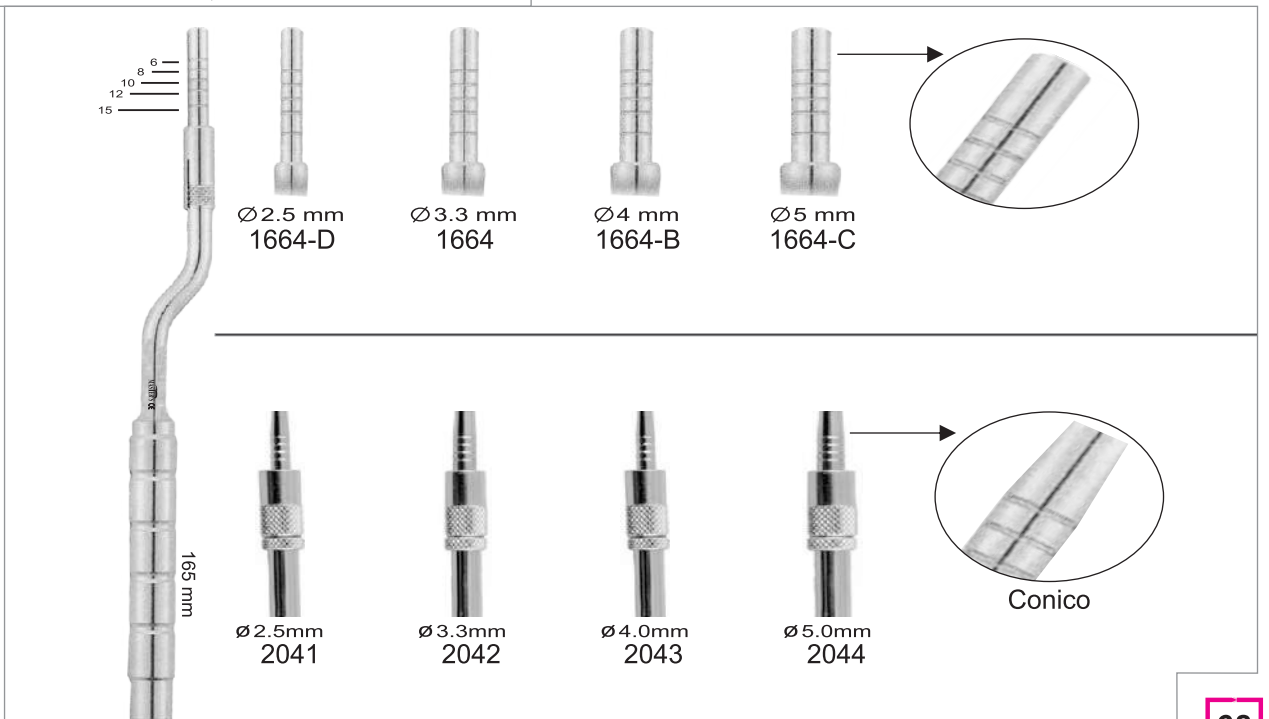



Implant Instruments

BISTURI CIRCULAR MANUAL

1433 5.1 mm (Inox)	
1434 4.5 mm (Inox)	
1435 4.1 mm (Inox)	
1436 3.5 mm (Inox)	
1437 3.0 mm (Inox)	

Tissue Punch



OUT	Ø 3.0mm	Ø 3.5mm	Ø 4.1mm	Ø 4.5mm	Ø 5.1mm	Ø 6.1mm
IN	Ø 2.2mm	Ø 3.0mm	Ø 3.3mm	Ø 3.9mm	Ø 4.1mm	Ø 5.1mm
	2057	2058	2059	2060	2061	2062



Ø 2.0mm	Ø 2.5mm	Ø 2.8mm	Ø 3.3mm	Ø 3.65mm	Ø 4.2mm	Ø 5.2mm
2063	2064	2065	2066	2067	2068	2069



Trephine Bur

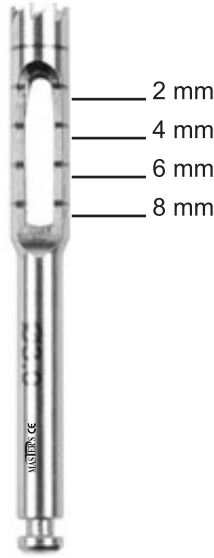

OUT \varnothing 3mm
IN \varnothing 2mm
2045

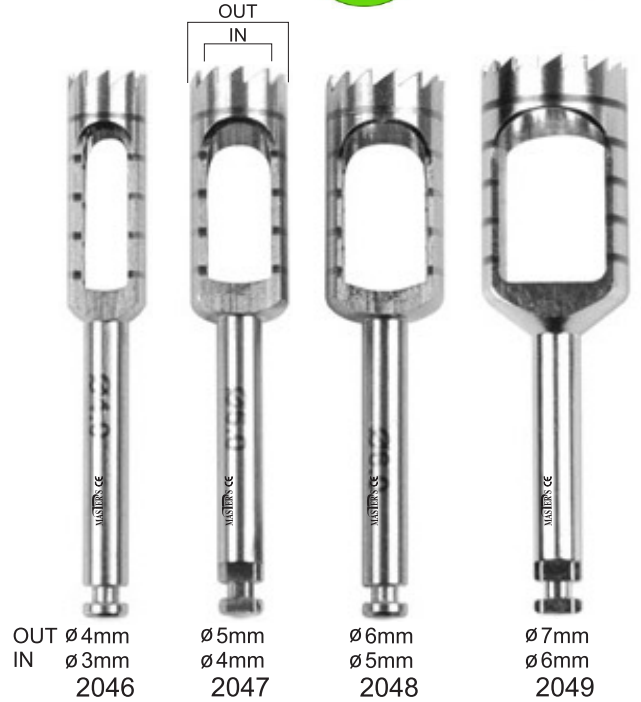

OUT \varnothing 4mm
IN \varnothing 3mm
2046



\varnothing 5mm
 \varnothing 4mm
2047



\varnothing 6mm
 \varnothing 5mm
2048



\varnothing 7mm
 \varnothing 6mm
2049



Bone Collector Trephine Bur

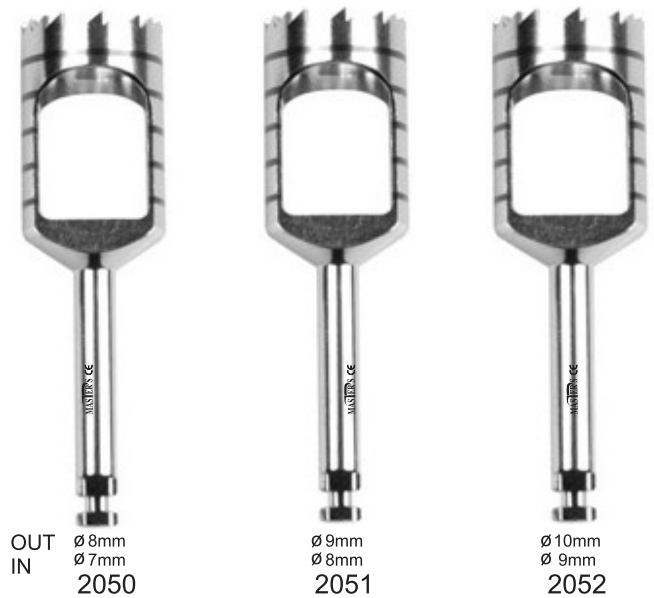

OUT \varnothing 8mm
IN \varnothing 7mm
2050



\varnothing 9mm
 \varnothing 8mm
2051



\varnothing 10mm
 \varnothing 9mm
2052



5mm
Stopper

Bone Remover
Bar \varnothing 3.4mm
2053



7mm
Stopper

Bone Remover
Bar \varnothing 3.9mm
2054



10mm
Stopper

Bone Remover
Bar \varnothing 4.2mm
2055



11.5mm
Stopper

Bone Remover
Bar \varnothing 5.2mm
2056



Torque Wrench / Ratchet Wrench



2088
Fix Point / Punta Fijo
4.0mm / Octagonal



2088 A
Ratchet Wrench / Square
4.0 mm



2088 B
Ratchet Wrench / Hexagonal
6.35 mm



2078
Torque Wrench/Square
10/45-Ncm
4.0mm



2087-2078 Set
Movable Point/Punta Mueve
Torque Wrench 6.35 mm
Torque Wrench/Square 4.00mm
10/45-Ncm



1.25mm



2214
Torque Wrench / Square
10/45-Ncm
Screw driver size 1.25mm

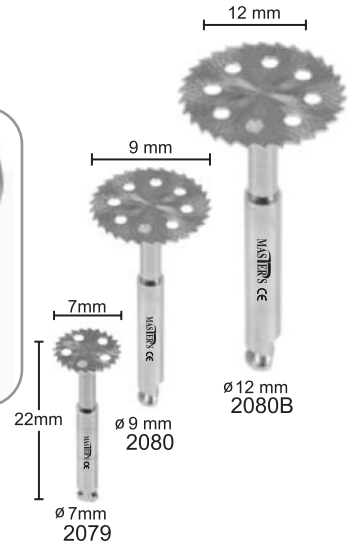

5 bone expander diameters



Ø 2.5mm 2070 Ø 3.0mm 2071 Ø 3.5mm 2072 Ø 4.0mm 2073 Ø 4.5mm 2074

4 score lines per expander

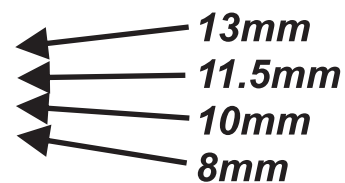



Lance Pilot Drills
1.2 and 1.5 mm. Diameter



Drill Extender



- 1.20mm (Hex) ○
- 1.25mm (Hex) ○
- 1.27mm (Hex) ○
- 1.30mm (Hex) ○
- 1 side ○
- 1 Cross ○
- 1 Small Star ○
- 1 Big Star ○

1850
Kit Dental
Implant Screw Driver
(Universal)
10 pcs/uni
Manual / RA

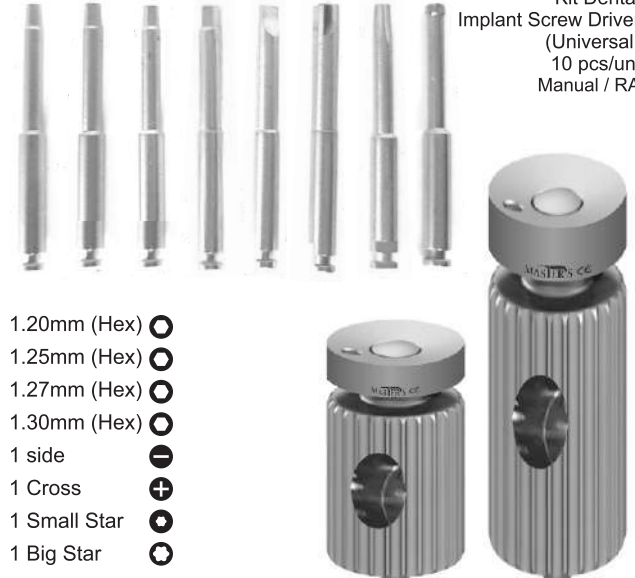

1.25 mm. Long/Regular/Short

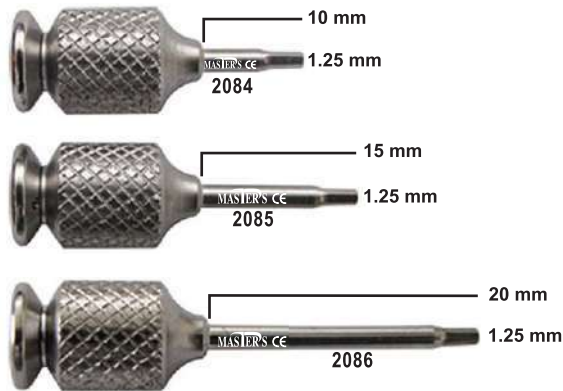

Hand Hex Driver 1.25mm

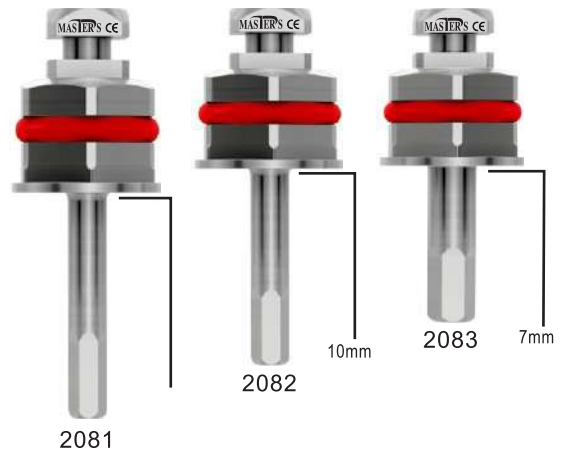

1.20 mm. Regular/Short

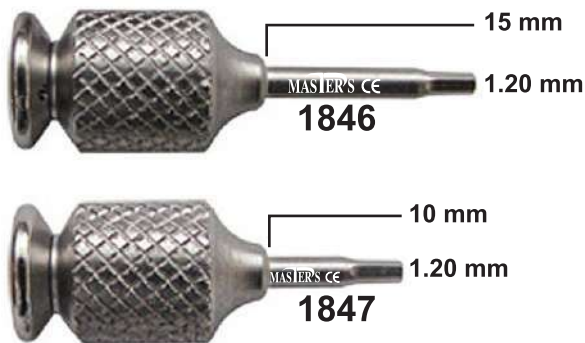

1.30 mm. Regular



1.27 mm. Regular





Bone Expander Kit



5 bone expander diameters



2.5 3.0 3.5 4.0 4.5mm

4 score lines per expander

13mm
 11.5mm
 10mm
 8mm

Ratchet Wrench



Pilot Drill

9 mm



Latch Style Hand Piece Adaptor

2089
 Bone Expander Kit (Complete)

Bone Collector Kit



2091
 Bone Crushing
 Triturador de Hueso

Surgical Long Drill Kit



2093
 Surgical Drill Kit

Bone Trimmer Kit



2092
 Bone Trimmer



NEODENTAL
INSTRUMENTOS DENTALES

639 942774

neodentallevante@gmail.com

Canada Office

Master Surgical Canada

597 ATWOOD CRESCENT PICKERING, LIW 3W7, ONTARIO CANADA. Tel:

1647-706-7976 / Cell: 1647-839-7976 /

USA Office

Surgical Corner Inc. Trupe Texas, U.S.A.